

ORDINANCE NO. 19-63

AN ORDINANCE AMENDING SECTIONS 18.01.020, AND CHAPTER 18.15 OF THE OLATHE MUNICIPAL CODE PERTAINING TO THE UNIFIED DEVELOPMENT ORDINANCE.

BE IT ORDAINED BY THE GOVERNING BODY OF THE CITY OF OLATHE, KANSAS:

WHEREAS, on June 17, 2014, the Governing Body of the City of Olathe adopted Ordinance No. 14-39, the *Unified Development Ordinance*; and

WHEREAS, the Governing Body directed staff and the Planning Commission to proceed with consideration of amendments to the Unified Development Ordinance on an annual basis; and

WHEREAS, proposed amendments (UDO19-0001) to the *Unified Development Ordinance* were reviewed at a planning session with the Governing Body on January 8, 2019; and

WHEREAS, proposed amendments to the *Unified Development Ordinance* were discussed at a Planning Commission workshop on July 8, 2019; and

WHEREAS, on July 22, 2019 the Planning Commission held a public hearing and recommended approval of the amendments as presented; and

WHEREAS, on October 1, 2019 the Governing Body reviewed and discussed UDO19-0001, the proposed amendments to Chapter 18.15 pertaining to building and site design requirements.

WHEREAS, the Governing Body reviewed the Planning Commission recommendation for proposed amendments and concurs with their recommendation.

BE IT ORDAINED BY THE GOVERNING BODY OF THE CITY OF OLATHE, KANSAS:

SECTION ONE: Section 18.01.020 of the Olathe Municipal Code (Unified Development Ordinance) is hereby amended to read as follows:

“18.01.020 Marked Copies of Ordinance on File. There shall not be less than three (3) copies of the Unified Development Ordinance, adopted by reference in Section 18.01.010 kept on file in the office of the City Clerk, to which shall be attached a copy of the incorporating ordinance, marked or stamped “Official Copies as Incorporated by Ordinance No. 14-39, as amended by Ordinance No. 15-16, Ordinance No. 16-20, Ordinance No. 16-51, Ordinance No. 17-01, Ordinance No. 17-52, Ordinance No. 18-48, Ordinance No. 19-26, Ordinance No. 19-40, Ordinance No. 19-56 and [Ordinance No. 19-63](#),” and open to inspection by the public at all reasonable hours. The police department, municipal judges, and all other departments of the City charged with the enforcement of the Unified Development Ordinance shall be supplied, at the cost of the City, with such number of official copies of such ordinance as may be deemed expedient.”

SECTION TWO: Chapter 18.15 of the Olathe Municipal Code (Unified Development Ordinance) is hereby amended to read as follows:

“Chapter 18.15

Composite Building and Site Design Standards

Contents

- 18.15.010** Generally
- 18.15.020** **Composite** Building Design Standards (Architecture)
- ~~**18.15.025** **Building Design Category A**~~
- ~~**18.15.030** **Building Design Category B**~~
- ~~**18.15.035** **Building Design Category C**~~
- ~~**18.15.040** **Building Design Category D**~~
- ~~**18.15.045** **Building Design Category E**~~
- ~~**18.15.050** **Building Design Category F**~~
- 18.15.100** **Composite** Site Design Standards
- 18.15.105** Site Design Category 1
- 18.15.110** Site Design Category 2
- 18.15.115** Site Design Category 3
- 18.15.120** Site Design Category 4
- 18.15.125** Site Design Category 5
- 18.15.130** Site Design Category 6”

SECTION THREE: Section 18.15.010 of the Olathe Municipal Code (Unified Development Ordinance) is hereby amended to read as follows:

“18.15.010 **Generally**

Purpose: This Chapter establishes a framework of guidelines, criteria, and standards for building and site design to:

- *Promote greater interest in the appearance, development, and redevelopment of all properties as it relates to a project, its surroundings, and throughout the community by providing guidance and direction for high quality development and redevelopment in Olathe; and*

- *Protect the public health, safety, and welfare of the City, residents, property owners, business owners, and visitors; and*
- *Implement the goals, objectives, and policies of Plan Olathe; and*
- *Encourage attractiveness, cohesiveness, and compatibility of buildings and sites ~~in order~~ to achieve harmonious appearance and function while protecting property values; and*
- *Provide guidance for development and redevelopment while protecting the City's rich history and protecting natural resources throughout the built environment; and*
- *Maintain and improve the qualities of, and relationships between, individual buildings, structures and the physical development in such a manner as to best contribute to the amenities and attractiveness of the City.*

A. These design composite standards are minimum requirements. Applicants are encouraged to use higher quality materials, more frequent building articulation, higher connectivity, a greater amount of open or civic spaces, or a greater percentage of sustainable or green building design or materials.

~~**B.** The architectural design of single-family residences, their materials and color, shall be visually harmonious with the overall appearance of the community, natural environment, and other high-quality development approved within the City. The exterior appearance of single-family residences shall consist of complimentary building materials and design features that provide a variation in amenities and features and incorporate high quality standards into the building layout, open space, natural topography, sustainability practices and overall character. The visual elements and amenities will be proportional to the relationships and patterns of the built and natural environment while providing decorative detailing and utilizing high quality materials.~~

~~**C.** The zoning regulations (Chapter 18.20) provide the combinations of building and site design that are allowed in each zoning district. In many districts, higher quality materials or more compact development patterns are associated with higher density, building height or floor area.~~

~~Instead of creating new zoning districts or a series of overlay districts, composite zoning embeds the standards for use, building design, and site design into general district categories. This creates a customized set of standards that the City can administer for all new zoning cases, instead of having to negotiate individual standards for each new application.~~

~~**D.** For the purposes of composite design standards, nonresidential uses (i.e., churches and schools) that are permitted in residential zoning districts will be considered under Building Design Category C~~

and Site Design Category 3. These types of uses should be comparable to a Neighborhood Commercial Center.

Example: The C-1 district provides a set of dimensional standards for Site Design Category 3 or 4 with Building Design Category D or E, Site Design Category 4 with Building Design Category C, or Site Design Category 3 with Building Design Category C. Building Design Category F and Site Design Categories 5 and 6 are not allowed in the C-1 district (Site Design Categories 1 and 2 and Building Design Categories A and B are applicable only to residential zoning districts)."

SECTION FOUR: Section 18.15.020 of the Olathe Municipal Code (Unified Development Ordinance) is hereby amended to read as follows:

“18.15.020 Composite Building Design Standards ([Architecture](#))

A.—Generally

A range of composite building design categories are provided to promote compatibility with surrounding land uses and community features, while providing realistic and flexible standards for new development. The required building design categories are based on the applicable zoning districts and type of use designated on the future land use map. Some building design categories are intended to promote design character and quality that are compatible with abutting features and neighborhoods (such as a key corridor or residential neighborhoods), while other areas are intended to promote maximum design flexibility. The range of design standards that apply in each building design category are briefly summarized in the table below. This summary table is for reference purposes only; the applicable design standards are detailed throughout the remainder of this Chapter.

Table 15-1. Summary of Composite Building Design Standards

	A	B	C	D	E	F
<i>Future/proposed land-use map category</i>	<i>Conventional, Conservation/Cluster Neighborhood</i>	<i>Mixed-Use Residential Neighborhood</i>	<i>Neighborhood Center, Urban Center, TOD</i>	<i>Commercial Corridor, Regional or Community Commercial Center</i>	<i>Employment Area</i>	<i>Industrial Area</i>
<i>Typical zoning district</i>	<i>R-1</i>	<i>R-2, R-3, R-4</i>	<i>N, C-1, D</i>	<i>C-2, C-3, C-4</i>	<i>O, BP, M-1</i>	<i>M-2, M-3</i>
Façade	No special	Highly	Highly	Moderately	Façade with a	Façade with a

	A	B	C	D	E	F
Future/proposed land-use map category	<i>Conventional, Conservation/Cluster Neighborhood</i>	<i>Mixed-Use Residential Neighborhood</i>	<i>Neighborhood Center, Urban Center, TOD Center</i>	<i>Commercial Corridor, Regional or Community Commercial Center</i>	<i>Employment Area</i>	<i>Industrial Area</i>
Typical zoning district	<i>R-1</i>	<i>R-2, R-3, R-4</i>	<i>N, C-1, D</i>	<i>C-2, C-3, C-4</i>	<i>O, BP, M-1</i>	<i>M-2, M-3</i>
Expression considerations	articulated façade, with a high level of transparency	articulated façade, with a high level of transparency	articulated façade, with a high level of transparency	articulated façade, with a moderate level of transparency	range of articulation and transparency	range of articulation and transparency
Pedestrian Orientation	Front-facing entry element (porch, stoop, etc.)	High level of ground-floor pedestrian interest with front-facing entries (porch, stoop, etc.)	High level of ground-floor pedestrian interest and transparency with front-facing entries (canopy, courtyard, etc.)	Moderate level of ground-floor pedestrian interest with front-facing entries (canopy, courtyard, etc.)	No special considerations	No special considerations
Materials considerations	No special considerations	High-quality materials	High-quality materials	Moderate quality materials	High-quality materials	A wide range of materials permitted
Garage design standards may apply	Garage door design standards may apply	Garage door design standards may apply	No special considerations	No special considerations	No special considerations	Overhead doors generally do not face primary streets
Transition Adjacent to Single-Family	No special considerations	Lower-scale adjacent to single-family	Lower-scale adjacent to single-family	Lower-scale adjacent to single-family	Lower-scale adjacent to single-family/ Façade adjacent to single-family treated as primary	Façade adjacent to single-family treated as primary/ Smaller-scale building modules adjacent to single-family

B.—Building Materials

1.—Building material standards are provided to ensure appropriate quality and visually coherent building designs. Materials for the primary and secondary building façade shall be selected from **Table 15-2** below according to the percentage specified for each materials category in the relevant composite building design standards.

Table 15-2. Permitted Building Materials by Materials Category

	Materials Category 1	Materials Category 2	Materials Category 3
Masonry			
Brick, solid	✓	✓	✓
Brick, modular	✓	✓	✓
Brick, panel/veneer		✓	✓
Brick, imprint or overlay systems			✓
Stone, modular	✓	✓	✓
Stone, veneer	✓	✓	✓
Stone, synthetic	✓	✓	✓
Stucco, genuine, detailed	✓	✓	✓
Stucco, synthetic/panels		✓	✓
Concrete, plain finish		✓	✓
Concrete, detailed	✓	✓	✓
Concrete Masonry Unit, flush/plain			✓
Concrete Masonry Unit, split faced		✓	✓
Concrete Masonry Unit, burnished	✓	✓	✓
Cement fiber board		✓	✓
Metals			
Architectural metal		✓	✓
Corrugated metal			✓

	Materials Category-1	Materials Category-2	Materials Category-3
Standard metal lap siding			✓
Aluminum Siding			✓
Glass			
Clear Glass	✓	✓	✓
Architectural panels	✓	✓	✓
Architectural block		✓	✓
Mirror glass	✓*	✓	✓
Opaque glass	✓*	✓	✓
Wood			
Other Synthetics		✓	✓
Synthetic stucco/EIFS			✓
Synthetic stucco/EIFS (detail only)		✓	✓
Vinyl siding			✓
Plastic (columns, details, etc.)			✓

* Mirror and opaque glass may be used as Category 1 Materials in M-1 and M-2 Districts only.

~~2. The permitting agency may approve building material(s) not listed in or reclassify a building material(s) for an individual project on **Table 15-2** if it finds that the material is similar or of higher quality to the other materials in the same category with regard to:~~

- ~~a. Durability and quality; and~~
- ~~b. Appearance; and~~
- ~~c. Sustainability practices; and~~
- ~~d. Compatibility with the architectural style of the buildings that are subject to the application for approval.~~

C. Roof Materials

~~Mansard and other visibly sloped roofs for commercial or mixed uses that are subject to Building Design Categories C, D or E (see Chapter 18.15) shall consist of tile, slate, standing seam metal, or~~

textured metal that resembles asphalt or tile. Metal, asphalt or composition shingle, or other materials with a synthetic or plastic appearance are not allowed.

D. Awnings and Canopies

~~1. Awnings and canopies that are located on a primary façade or are visible from the street shall:~~

~~a. Commercial or mixed uses that are subject to Building Design Categories C, D or E (see Chapter 18.15) shall use non-vinyl materials that are durable in the local climate such as commercial grade fabric, canvas, tile, slate, or similar materials. Metal, asphalt or composition shingle, or other materials with a synthetic or plastic appearance are not allowed.~~

~~b. Use materials with a matte finish.~~

~~c. Use a single color or two color stripes.~~

~~d. Be placed within, rather than overlapping, the vertical elements of a building façade that is divided into distinct structural bays.~~

~~2. Awnings and canopies that are not located on a primary façade and are not visible from the street may comply with subsection 1, or:~~

~~a. Use glossy or shiny plastic, or materials with a similar shiny appearance.~~

~~b. Use internal illumination.~~

E. Gutters and Downspouts

~~1. The location and design of exposed gutters and downspouts shall be identified on building elevations submitted for approval.~~

~~2. Exposed gutters and downspouts that are located on the primary façades of nonresidential structures subject to Building Design Categories C, D, E or F shall meet the following criteria:~~

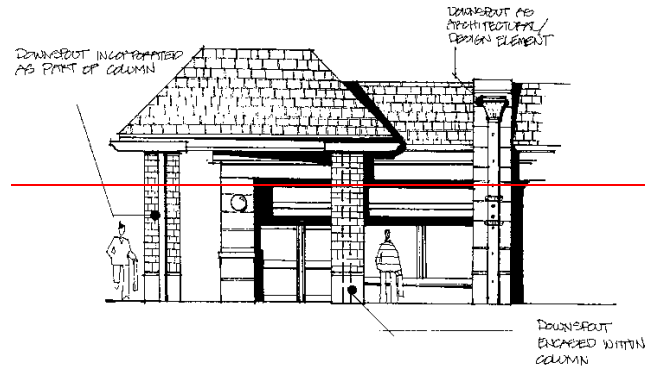

~~a. Exposed gutters are prohibited for use with flat roofs.~~

~~b. Downspouts shall be enclosed within the building walls so that they are not exposed. Exceptions may be granted by the Approving Authority to allow exposed downspouts, provided that they are either:~~

~~(i) designed by the architect as decorative architectural elements that are an integral component of the building design and coordinated with vertical elements such as towers, columns, or pilasters; or~~

~~(ii) located only at interior corners of the building and painted to match or coordinate with the façade in order to minimize their appearance.~~

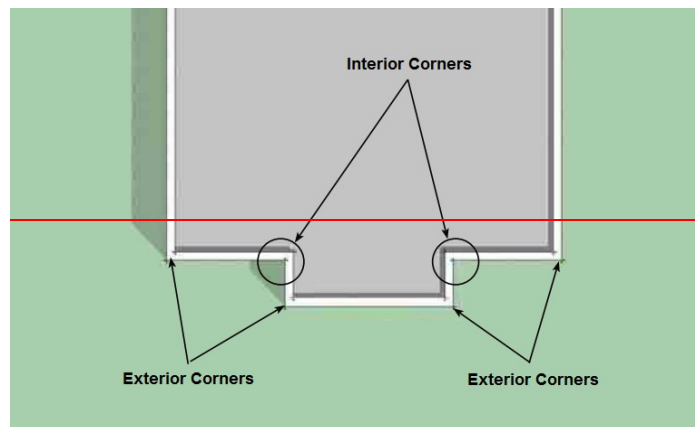

~~c. Exposed gutters and downspouts shall be constructed of high quality, commercial-grade metal.~~

~~3. Interpretations of subsection 2 shall be determined by the Planning Official.~~

F. Rooftop Screening

~~1. All applications for preliminary or final development plan approval shall include information regarding anticipated rooftop equipment, including mechanical units, vents, pipes, and other appurtenances. Such equipment shall be indicated on building elevations where the size and location of such equipment is known, and any anticipated equipment or equipment locations not yet determined shall be described in the notes on the building elevations along with the estimated maximum dimensions of such equipment and the intended methods of screening.~~

~~2. All rooftop equipment shall be screened from public view with an architectural treatment which is compatible with the building architecture and integral to the overall appearance of the building. An example includes a parapet wall that includes the same building materials as the lower levels of the building façade.~~

~~3. For purposes of this chapter, the phrase "architectural treatment compatible with the building architecture" does not include painted or prefinished rooftop equipment.~~

~~4. For rooftop equipment not adequately screened by the parapet, a supplementary screen shall be provided by the use of prefinished architectural metal panels, stucco panels, masonry walls, or similar building materials.~~

~~5. The height of the screen shall be no lower than the height of the equipment.~~

~~6. Screening shall not interfere with Fire Department access to the roof.~~

~~7. The Approving Authority may waive or amend rooftop equipment screening requirements as part of a preliminary or final site development plan if the applicant provides a sight line visibility study and alternative screening provisions if needed, and the approving authority finds that:~~
(Ord. 09-22 § 13, 2009)

~~a. The building is located at a high elevation in relation to surrounding properties, and it is demonstrated that rooftop equipment will not be visible; or~~

~~b. The building is located in the middle of an industrial park and rooftop equipment is not visible from arterial roadways or residential properties, and will not have a negative impact upon any sensitive areas or scenic view or vistas; or~~

~~c. The building is sited in a manner where the location and setback of rooftop equipment from the building edge in relation to the elevation and visibility of surrounding properties is~~

such that the equipment will not be visible from any distance and additional screening measures are not required.

~~8. In the event that any rooftop equipment has not yet been determined at the time of final development plan approval, or changes are made to rooftop equipment after the final development plan is approved, the applicant must provide suitable screening to meet the above criteria, subject to review and approval by the Planning Official. (Ord. 18-48 § 2, 2018; Ord. 16-20 § 4, 2016; Ord. 15-16 § 3, 2015)~~

SECTION FIVE: Section 18.15.025 of the Olathe Municipal Code (Unified Development Ordinance) is hereby amended to read as follows:

~~18.15.025—Building Design Category A~~

~~Composite Building Design Category A provides standards to ensure compatible development in areas designated by Plan Olathe as **Conventional Neighborhoods** and **Conservation/Cluster Neighborhoods**. The following general design standards apply to all projects in Building Design Category A. **Note: Category A does not apply to single-family dwelling units on lots exceeding 7,200 square feet.**~~

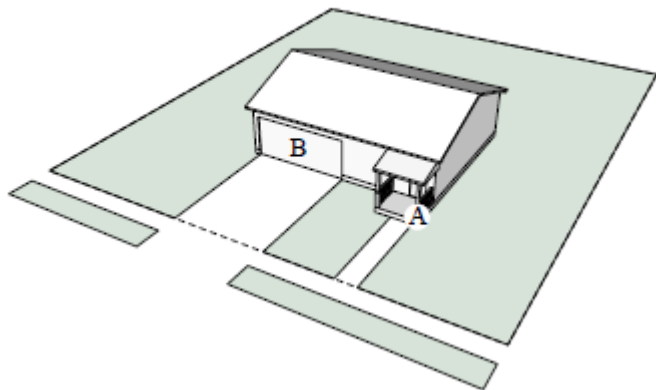

Table 15-3. General Design Standards for Building Design Category A

Pedestrian Orientation		
A	Front-Facing Entry Element on Primary Façade	Required—See menu options
B	Garage Subordinate to Primary Façade of One-story Buildings	Required—See menu options
Exterior Building Materials		
C	Building Materials on Primary Façades (min. % from Materials Category 1 / max. % Materials Category 2)	70% / 30%

A. Menu of Entry Elements for Building Design Category A

All buildings in Building Design Category A must incorporate a front-facing entry element to signal the connection between the sidewalk and the house. An entry element shall be placed either on the primary façade, or be visible from the street. It may extend a maximum of 5 feet into the minimum front setback area, not including stairs or landings. The following entry elements meet the front-facing entry requirement:

Front Porch

A roofed but unenclosed entry element with a minimum width of 8 feet and depth of 4 feet—Partial walls or railings may be no more than 4 feet tall.

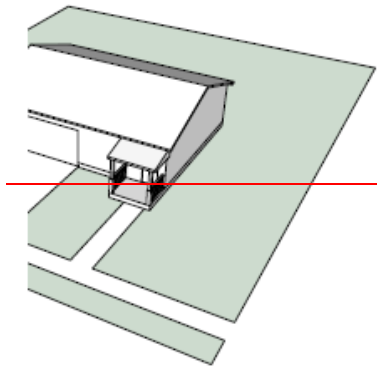

Side Entry

A roofed but unenclosed entry element with a minimum depth of 4 feet projecting from a side-facing doorway.

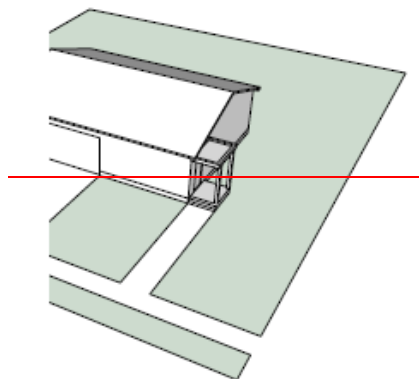

Recessed Entry

An entry recessed at least 2 feet into the primary façade.

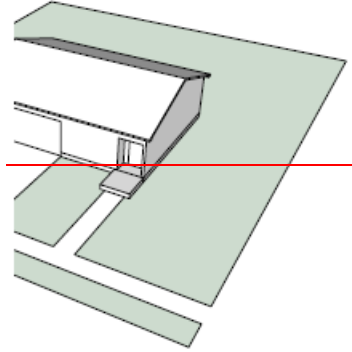

B. Menu of Garage Door Options for Building Design Category A

Buildings in Building Design Category A that are less than two stories in height must have garage doors that are subordinate to the primary façade to minimize visual impacts and encourage pedestrian orientation. Select at least one of the following options:

Front-Facing Garage Door with Limited Width

Front-facing garage door(s) extending a maximum of 50% of the primary façade width or 28 feet, whichever is greater.

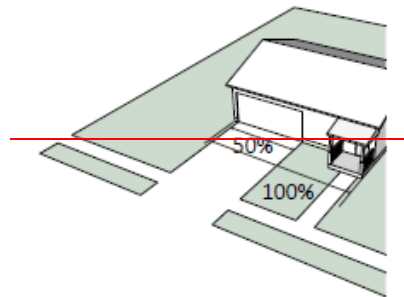

Garage Door Set Back from Primary Façade

Front-facing garage door(s) set back at least 5 feet from the primary façade.

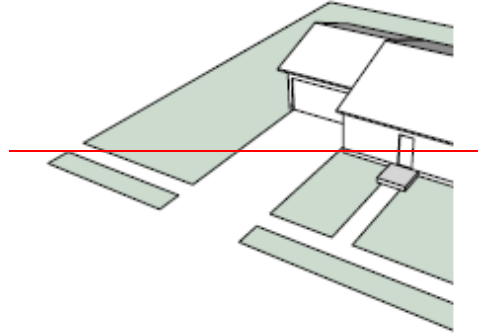

Side or Rear Facing Garage Doors

Garage door(s) oriented perpendicular to the street or facing the opposite direction from the street.

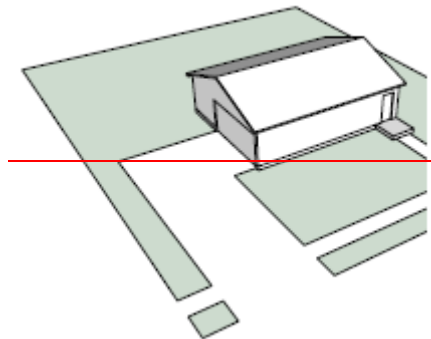

C.—Building Materials on Primary Façades for Building Design Category A

See Table 15-3.”

SECTION SIX: Section 18.15.030 of the Olathe Municipal Code (Unified Development Ordinance) is hereby amended to read as follows:

~~“18.15.030—Building Design Category B~~

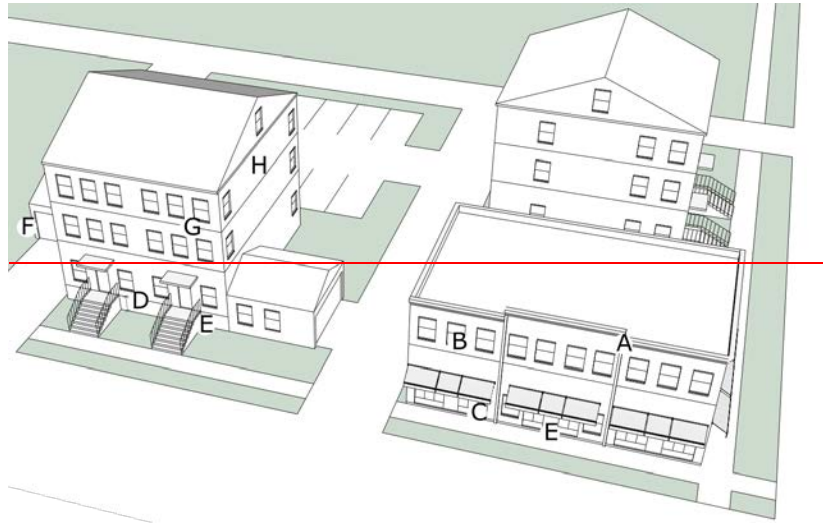

~~Composite Building Design Category B provides standards to ensure compatible development in areas designated by PlanOlathe as Mixed-Use Residential Neighborhoods. The following general design standards apply to all projects in Building Design Category B:~~

Table 15-4. General Design Standards for Building Design Category B

Façade Expression		
A	Horizontal and Vertical Articulation of Primary Façade	Required—See menu options
B	Transparent Glass on Primary Façade (min. %)	25%
Pedestrian Orientation		
C	Ground-Floor Pedestrian Interest	Required—See menu options
D	Residential Finished Floor Elevation Above Sidewalk (min)	18 inches
E	Front-Facing Entry Element on Primary Façade	Required—See menu options
F	Garage Subordinate to Primary Façade	Required—See menu options
Exterior Building Materials		
G	Building Materials on Primary Façades (min. % from Materials Category 1 / max. % Materials Category 2)	70% / 30%
H	Building Materials on Secondary Façades (min. % from Materials Category 1 / max. % Materials Category 2)	50% / 50%
Transition Standards		

A.—Menu of Articulation Tools for Building Design Category B

All buildings in Building Design Category B must incorporate horizontal and vertical primary façade articulation to divide building mass into human scale modules.

1.—Horizontal Articulation

One or more of the following horizontal articulation tools must be used a minimum of every 50 feet of linear façade width, or per each ground floor residential unit (if units are less than 50 feet wide):

a.—Wall Offset

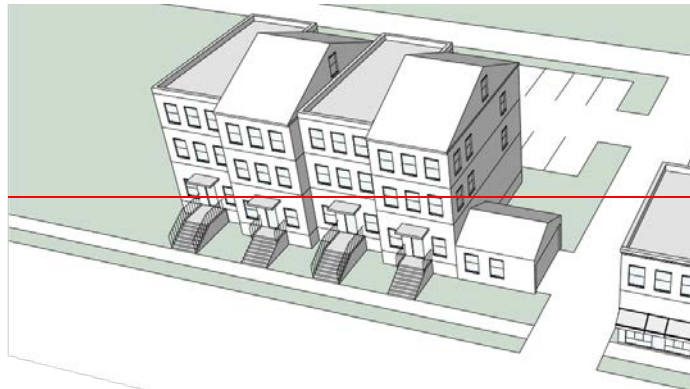

A horizontal wall plane offset of at least 4 feet, extending for the full height of the primary façade.

b.—Wall Notch

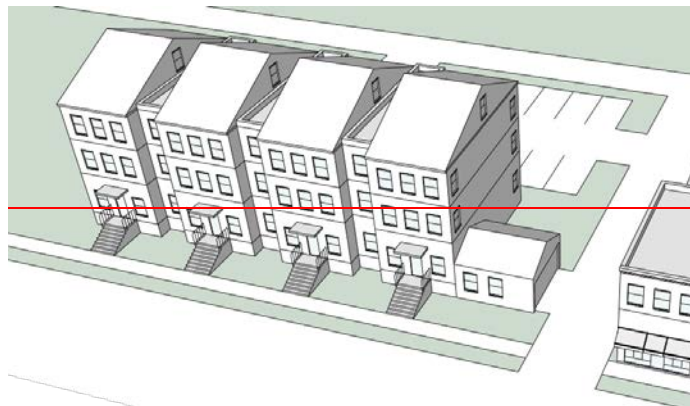

A setback or notch in the wall plane at least 4 feet deep and 8 feet wide for the full height of the primary façade.

c. Wall projection

A projection or molding at least 4 inches deep and 1 foot wide for the full height of the primary façade.

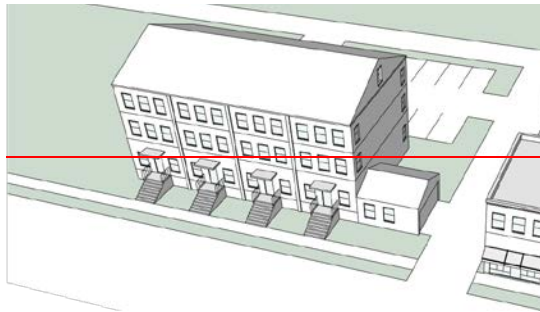

2. Vertical Articulation

One or more of the following vertical articulation tools must be used a minimum of every 50 feet of linear façade width:

a. Variation in Height as viewed from the street

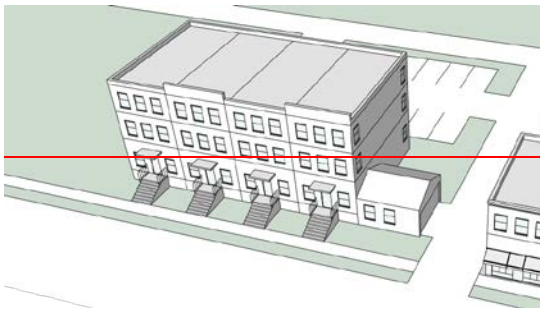

A variation in building or parapet height of at least 2 feet (or 4 feet for buildings greater than two stories in height).

b. Variations in Roof Form

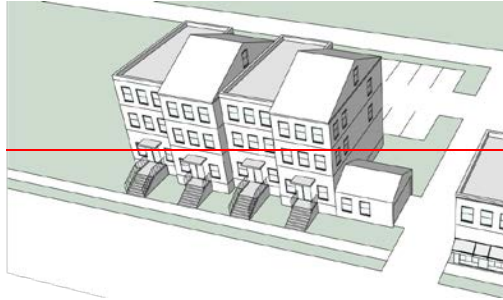

Use of more than one roof form to express different building modules.

B.—Transparent Glass on Primary Façade for Building Design Category B

See Table 15-4.

C.—Menu of Ground Floor Pedestrian Interest Tools for Building Design Category B

All buildings in Building Design Category B must use transparent glass or other tools to promote pedestrian interest at the ground floor of the primary façade. At least 50% of the ground floor wall area on the primary façade of commercial buildings and 25% of the ground floor wall area on the primary façade of residential buildings must be covered with one or more of the following tools:

1.—Transparent Glass



Window and door areas with transparent glass (also counts toward minimum transparent glass on primary façade).

2.— Architectural Details

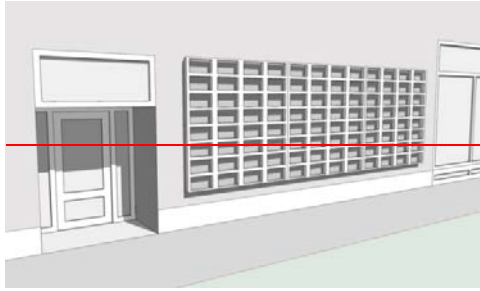

Installation of green screens or other architectural details.

3.— Integrated Planters

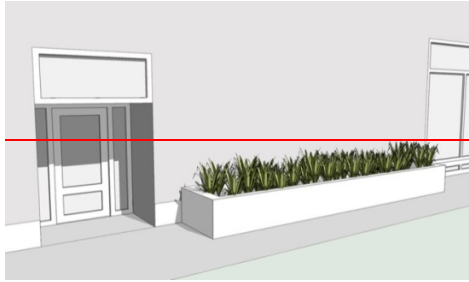

Permanent planters at least 3 feet in height, attached to the ground floor of the building.

The wall area covered by planters is calculated according to the length of façade covered by the planter.

4.— Entry Elements



Incorporation of entry elements from the Menu of Entry Elements for Building Design Category B (see next page).

D.— Residential Finished Floor Elevation for Building Design Category B

See Table 15-4.

E. Menu of Entry Elements for Building Design Category B

All buildings in Building Design Category B must incorporate a front-facing entry element to signal the connection between the sidewalk and the building or residential unit. One entry element shall be provided for each primary ground-floor use in the building and each ground-floor residential use with an exterior entry. An entry element shall be placed either on the primary façade, or be visible from the street. It may extend a maximum of 5 feet into the minimum front setback area, not including stairs or landings. The following entry elements meet the front-facing entry requirement:

1. Awning/Canopy

A horizontal projecting element cantilevered at least 4 feet from a wall or window area above the entry, and at least 10 feet above the sidewalk below.



2. Front Porch

A roofed but unenclosed entry element with a minimum width of 8 feet and depth of 4 feet. Partial walls or railings may be no more than 4 feet tall.

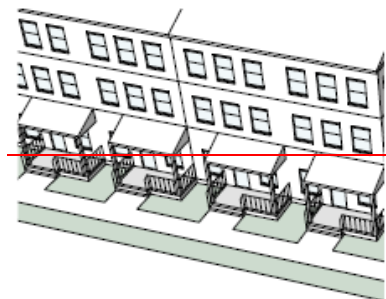

3.—Stoop

A raised and unenclosed (may be roofed) landing and stairway with a maximum depth of 4 feet and a maximum width of 4 feet not including the stairs—Partial walls or railings may be no more than 4 feet tall.

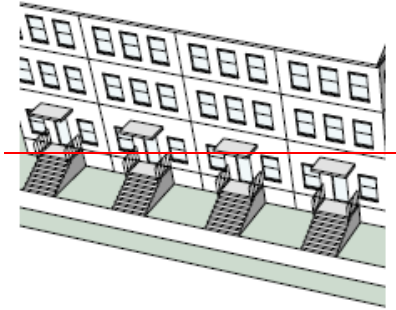

F.—Menu of Garage Door Options for Building Design Category B

Garage doors in Building Design Category B must correspond with one of the following options to minimize blank wall area on the primary façade and limit the impact of vehicular use areas on pedestrians:

1.—Garage Door Set Back from Primary Façade

Front-facing garage door(s) set back from the primary façade or located in a detached structure to the rear of the primary structure.

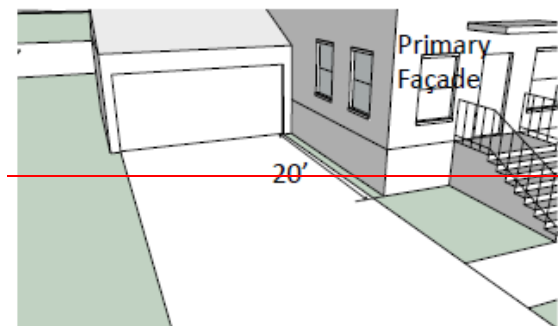

2.—Side or Rear Facing Garage Doors

Garage door(s) oriented perpendicular to the street or facing the opposite direction from the street.

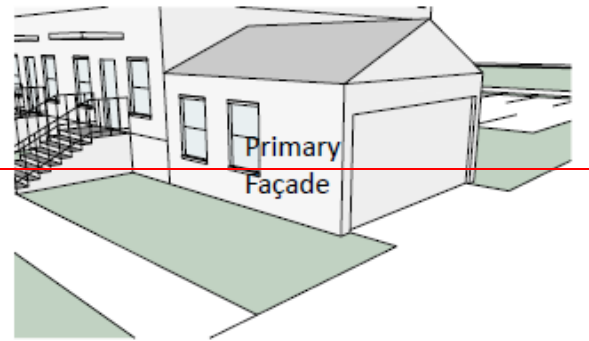

G. Building Materials on Primary Façades for Building Design Category B

See Table 15-4.

H. Building Materials on Secondary Façades for Building Design Category B

See Table 15-4.

I. Transition Standards for Projects Adjacent to Single-Family Neighborhoods

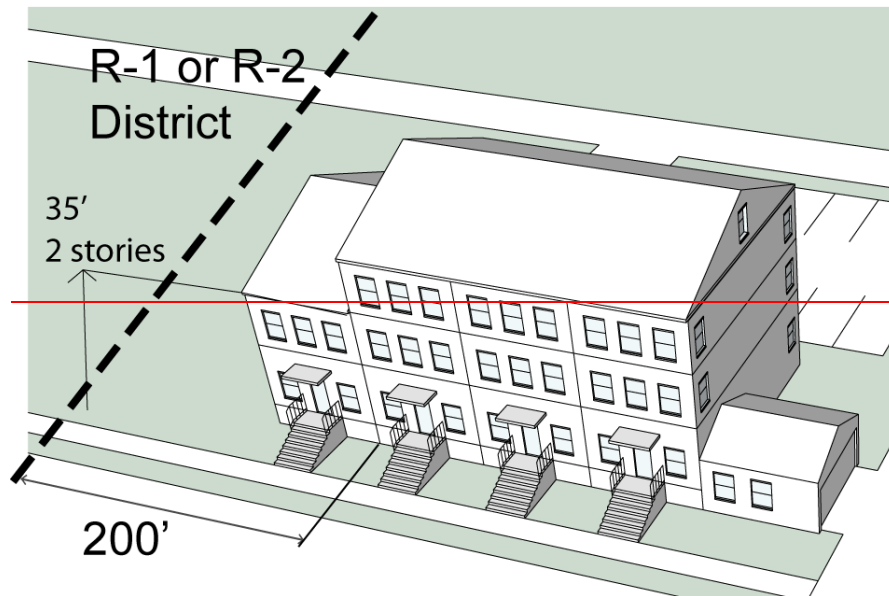

A building or portion of a building located within 100 feet of an R-1 or R-2 district may be no more than 35 feet or two stories in height."

SECTION SEVEN: Section 18.15.035 of the Olathe Municipal Code (Unified Development Ordinance) is hereby amended to read as follows:

~~“18.15.035—Building Design Category C~~

~~Composite Building Design Category C provides standards to ensure compatible development in areas designated by Plan Olathe as **Neighborhood Commercial Centers, Urban Centers and Transit Oriented Development Centers** and **Cedar Creek Mixed Use Centers**. The following general design standards apply to all projects in Building Design Category C:~~

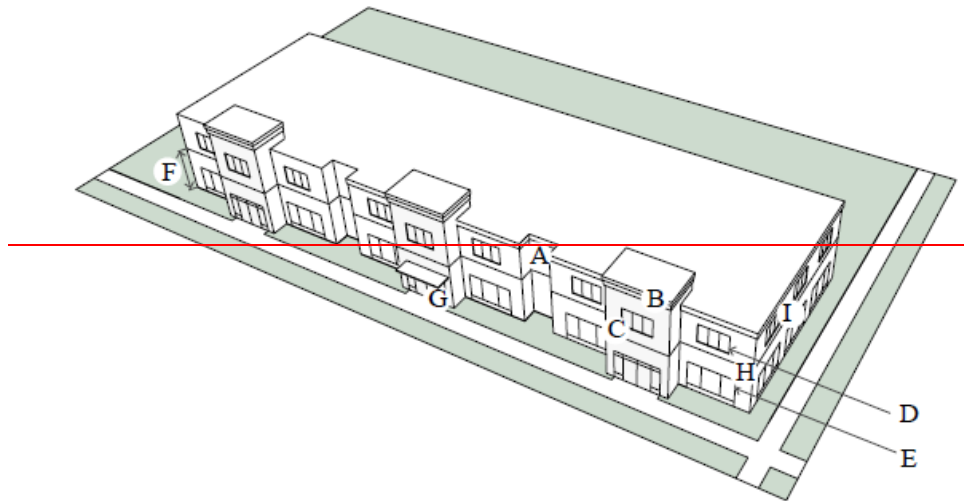

Table 15-5. General Design Standards for Building Design Category C

Façade Expression		
A	Horizontal and Vertical Articulation of Primary Façade	Required—See menu options
B	Focal Point Elements on Primary Façade	Required—See menu options
C	Additional Primary Façade Expression	Required—See menu options
D	Transparent Glass on Primary Façades (min.%)	30%
Pedestrian Orientation		
E	Ground Floor Pedestrian Interest	Required—See menu options
F	First Floor Height (min.)	11 feet
G	Front Facing Entry Element on Primary Façade	Required—See menu options
Exterior Building Materials		
H	Building Materials on Primary Façades (min. % from Materials Category 1 / max. % Materials Category 2)	80% / 20%

I	Building Materials on Secondary Façades (min. % from Materials Category 1 / max. % Materials Category 2)	60% / 40%
----------	--	-----------

Transition Standards

J	Transition to R-1 and R-2 Districts	Required—See text
----------	-------------------------------------	-------------------

Overhead Doors

K	Location of Overhead Doors for Vehicular Access	May not be located on primary façade
----------	---	--------------------------------------

A. Menu of Articulation Tools for Building Design Category C

All buildings in Building Design Category C must incorporate horizontal and vertical primary façade articulation to divide building mass into human scale modules.

1. Horizontal Articulation

One or more of the following horizontal articulation tools must be used a minimum of every 50 feet of linear façade width:

a. Wall Offset

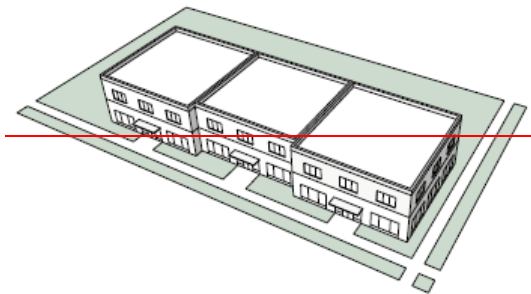

A horizontal wall plane offset of at least 4 feet, extending for the full height of the façade.

b. Wall Notch

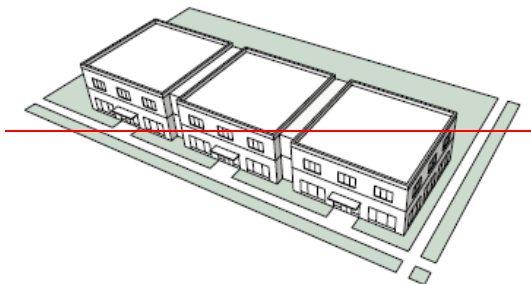

A setback or notch in the wall plane at least 4 feet deep and 8 feet wide for the full height of the façade.

c. Wall projection

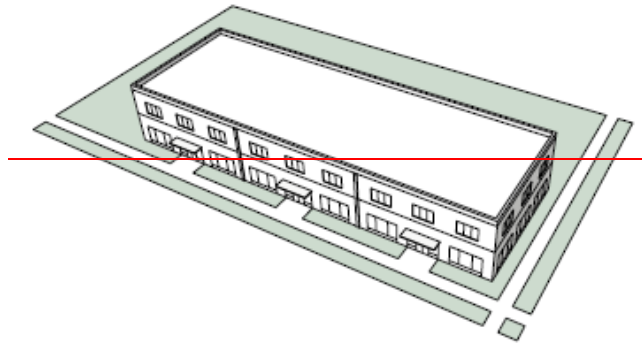

A projection or molding at least 4 inches deep and 1 foot wide for the full height of the façade.

2. Vertical Articulation

One or more of the following vertical articulation tools must be used a minimum of every 50 feet of linear façade width:

a. Variation in Height as viewed from the street

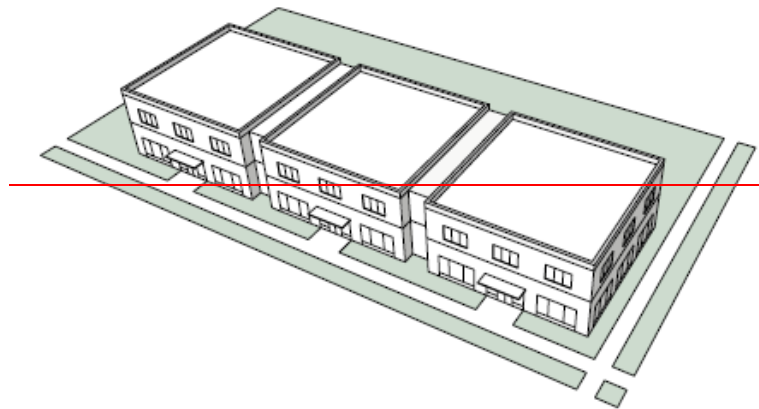

A variation in building or parapet height of at least 2 feet (or 4 feet for buildings greater than two stories in height).

b. Variations in Roof Form

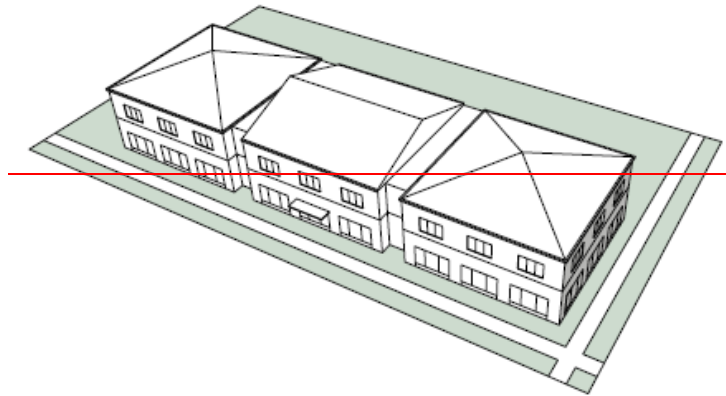

Use of more than one roof form to express different building modules.

B. Menu of Focal Point Elements for Building Design Category C

All buildings in Building Design Category C must incorporate focal point design elements to help define the character of the structure. Select one or more of the following focal point design elements:

1. Tower or Raised Parapet Element

Towers or raised roof parapets that produce variations in building height of at least 4 feet and project at least 1 foot from the front and rear of the primary façade plane.

2. Cap Element

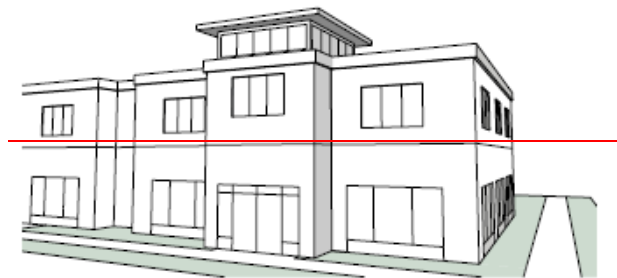

A design element projecting above the roofline and incorporating clerestory windows or other transparent areas.

3. Pitched Roof Elements



A design element incorporating a pitched roof or gable roof end.

C. Menu of Additional Façade Expression Tools for Building Design Category C

All buildings in Building Design Category C must incorporate additional façade expression to add visual interest. For buildings up to two stories in height, one option must be selected from the following list. For buildings over two stories in height, two options must be selected:

1. Expression Line



A horizontal projection (or combination of projections) such as a molding or series of balconies extending along at least 60% of the linear façade width above the first floor level.

2. Change in Materials

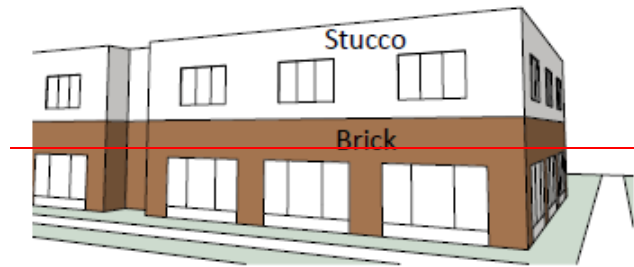

A change in materials between lower and upper floors for the full length of the primary façade.

3. Awning/Canopy



Use of an awning or canopy above transparent glass windows or other ground floor pedestrian interest areas for at least 60% of the linear façade width. (Note that these design elements may also be used to meet requirements for front-facing entry elements).

4. Arcade/Gallery/Veranda/Pergola



Roofed (or partially roofed), arcade, gallery, veranda or pergola elements that are not enclosed on more than two sides and extend at least 6 feet over or towards the sidewalk along at least 10% of the linear façade width, or a minimum of 30 feet (note that these design elements may also be used to meet requirements for front-facing entry elements).

5. Ornamental Cornice

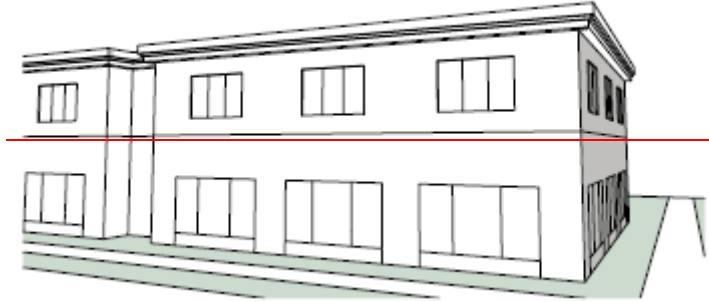

A cornice projecting a minimum of 6 inches from the primary façade at the top floor parapet level for at least 60% of the linear façade width.

D. Transparent Glass on Primary Façade for Building Design Category C

See Table 15-5.

E. Menu of Ground Floor Pedestrian Interest Tools for Building Design Category C

All buildings in Building Design Category C must incorporate expanded transparent glass areas or use other tools to promote pedestrian interest at the ground floor of the primary façade. A minimum of 60% of the ground floor wall area on the primary façade must be covered using one of the tools listed below:

1. Transparent Glass

Window and door areas with transparent glass (also counts toward minimum transparent glass on primary façade).

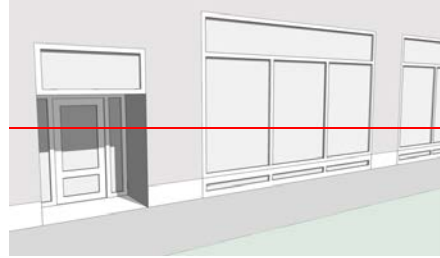

2.—Architectural Details

~~Installation of green screens or other architectural details.~~

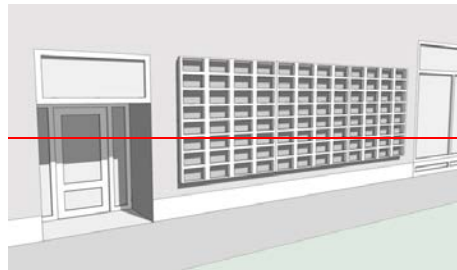

3.—Display Cases

~~Installation of integrated display cases.~~

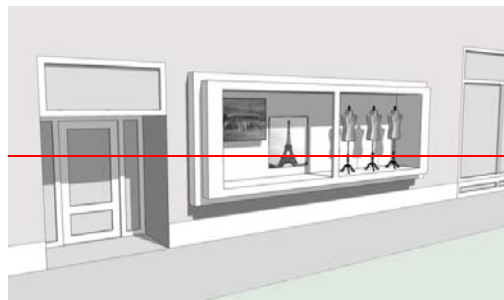

4.—Entry Elements

Incorporation of entry elements from the Menu of Entry Elements for Building Design Category C (see next page):

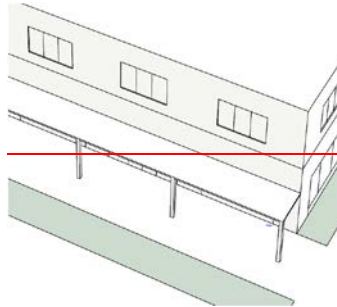

F.—First Floor Height for Building Design Category C

See Table 15-5.

G.—Menu of Entry Elements for Building Design Category C

All buildings in Building Design Category C must incorporate a front-facing entry element to signal the connection between the sidewalk and the building or residential unit. One entry element shall be provided for each primary ground floor use in the building. An entry element shall be placed either on the primary façade, or be visible from the street. It may extend a maximum of 5 feet into the minimum front setback area, not including stairs or landings. The following entry elements meet the front-facing entry requirement:

1.—Awning/Canopy

A horizontal projecting element cantilevered at least 4 feet from a wall or window area above the entry, and at least 10 feet above the sidewalk below.

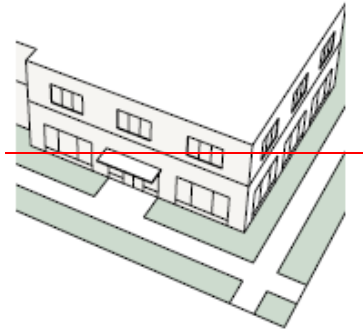

2. Courtyard

A court, patio or other indentation in the building façade at least 6 feet deep—building entry doors may face onto the patio from any direction.

⇐ Applicants may also use entry options 1 and 3 to meet requirements for additional primary façade expression.

⇒

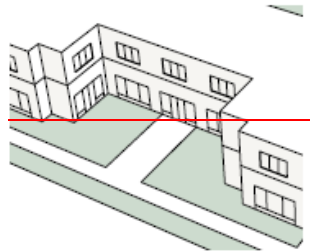

3. Gallery/Arcade

Roofed (or partially roofed), arcade, gallery, veranda or pergola elements that are not enclosed on more than two sides and extend at least 6 feet over or towards the sidewalk.

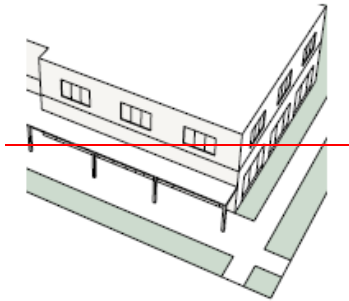

~~4. Front Porch¹~~

~~A roofed but unenclosed entry element with a minimum width of 8 feet and depth of 4 feet—
Partial walls or railings may be no more than 4 feet tall.~~

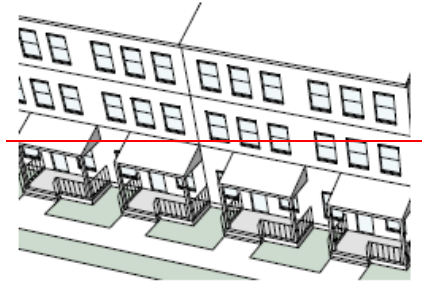

~~5. Stoop¹~~

~~A raised and unenclosed (may be roofed) landing and stairway with a maximum depth of 4 feet
and a maximum width of 4 feet not including the stairs—Partial walls or railings may be no more
than 4 feet tall.~~

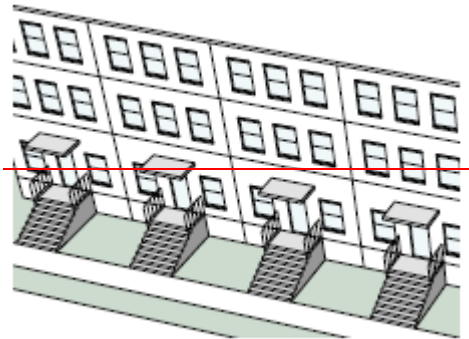

~~¹ Allowed for residential buildings or units only.~~

~~H. Building Materials on Primary Façades for Building Design Category C~~

~~See Table 15-5.~~

~~I. Building Materials on Secondary Façades for Building Design Category C~~

~~See Table 15-5.~~

~~J. Transition Standard for Projects Adjacent to Single-Family Neighborhoods~~

A building or portion of a building located within 50 feet of district R-1 or R-2 may be no more than 35 feet or two stories in height.

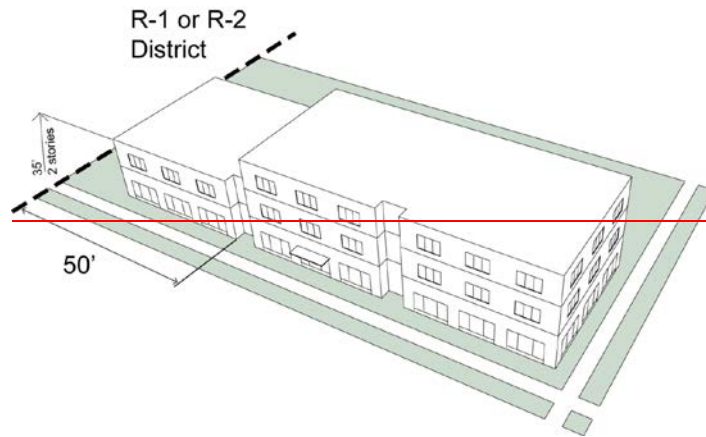

K. Overhead Doors / Loading Docks

- ~~1. Overhead Doors or Loading Docks shall face the rear lot line or an alley.~~
- ~~2. Overhead doors that allow only pedestrian access may face a front lot line. (Ord. 16-20 § 4, 2016)~~

SECTION EIGHT: Section 18.15.040 of the Olathe Municipal Code (Unified Development Ordinance) is hereby amended to read as follows:

~~**18.15.040 Building Design Category D**~~

~~Composite Building Design Category D provides standards to ensure compatible development in areas designated by Plan Olathe as Commercial Corridors, Community Commercial Centers and Regional Commercial Centers. The following design standards apply to all projects in Building Design Category D:~~

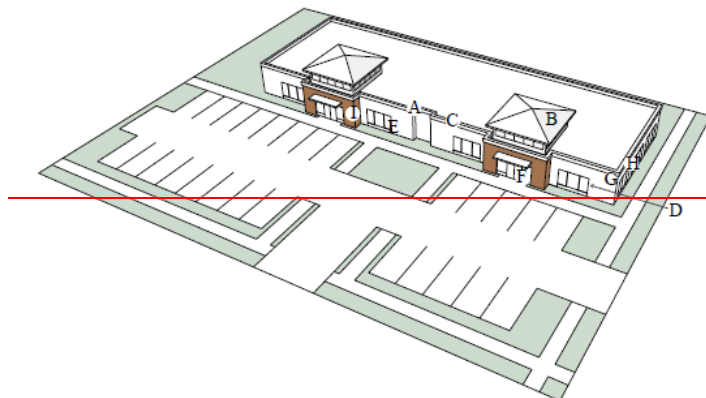

Table 15-6. General Building Design Standards for Building Design Category D

Façade Expression		
A	Horizontal and Vertical Articulation of Primary Façade	Required—See menu options
B	Focal Point Elements on Primary Façade	Required—See menu options
C	Additional Primary Façade Expression	Required—See menu options
D	Transparent glass on Primary Façades (min. %)	20% ¹
Pedestrian Orientation		
E	Ground Floor Pedestrian Interest	Required—See menu options
F	Front-facing Entry Element on Primary Façade	Required—See menu options
Exterior Building Materials		
G	Building Materials on Primary Façades (min. % Materials Category 1 / max. % Materials Category 2)	70% / 30% ²
H	Building Materials on Secondary Façades (min. % Materials Category 1 / max. % Materials Category 2)	60% / 40%
I	Mix of Building Materials on Primary Façades	Required—See menu options
Transition Standards		
J	Transition to R-1 and R-2 Districts	Required—See text
Overhead Doors		
K	Location of Overhead Doors for Vehicular Access	May not be located on primary façade ³

1 Applicants may use spandrel glass to meet a portion of this requirement.

2 Primary Façade Materials may be reduced to 60% / 40% if a mix of building materials is incorporated (see letter I).

3 Overhead doors that are not used for vehicular access may be located on a primary façade.

A. Menu of Articulation Tools for Building Design Category D

All buildings in Building Design Category D must incorporate horizontal and vertical primary façade articulation to divide building mass into human scale modules.

1. Horizontal Articulation

One or more of the following horizontal articulation tools must be used a minimum of every 75 feet of linear façade width:

a. ~~Wall Offset~~

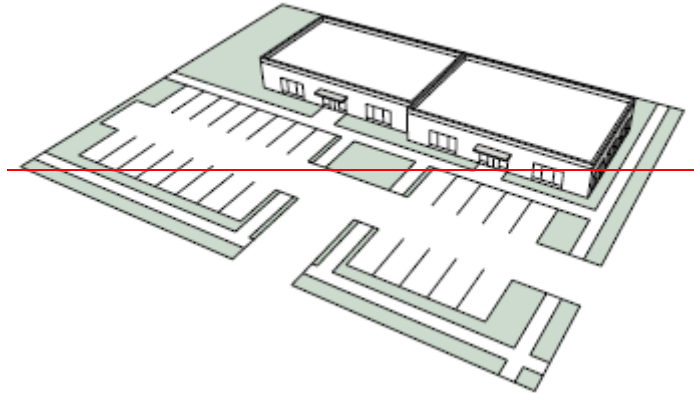

A horizontal wall plane offset of at least 4 feet, extending for the full height of the façade.

b. ~~Wall Notch~~

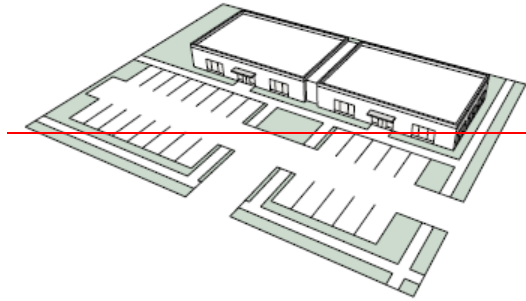

A setback or notch in the wall plane at least 4 feet deep and 8 feet wide for the full height of the façade.

c. ~~Wall projection~~

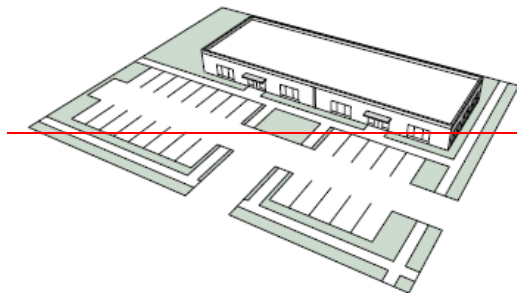

A projection or molding at least 4 inches deep and 1 foot wide for the full height of the façade.

2. Vertical Articulation

One or more of the following vertical articulation tools must be used a minimum of every 75 feet of linear façade width:

a. Variation in Height as viewed from the street

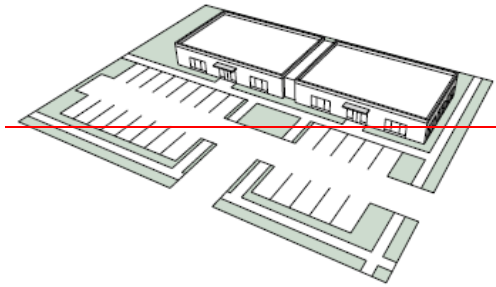

A variation in building or parapet height of at least 2 feet (or 4 feet for buildings greater than two stories in height).

b. Variations in Roof Form

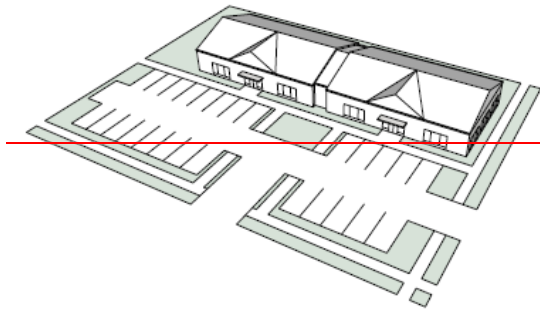

Use of more than one roof form to express different building modules.

B. Menu of Focal Point Elements for Building Design Category D

All buildings in Building Design Category D must incorporate focal point design elements to help define the character of the structure. Select one or more of the following focal point design elements:

1. Tower or Raised Parapet Element

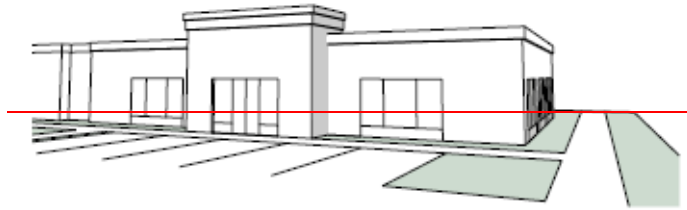

Towers or raised roof parapets that produce variations in building height of at least 4 feet and project at least 1 foot from the front and rear of the primary façade plane.

2. Cap Element

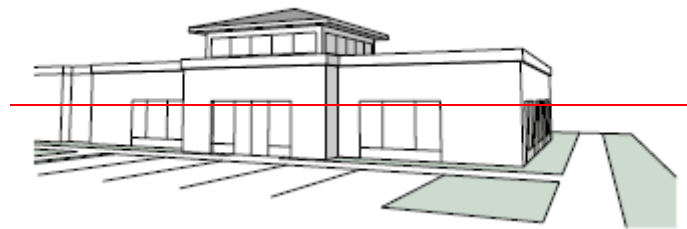

A design element projecting above the roofline and incorporating clerestory windows or other transparent areas.

3. Pitched Roof Elements

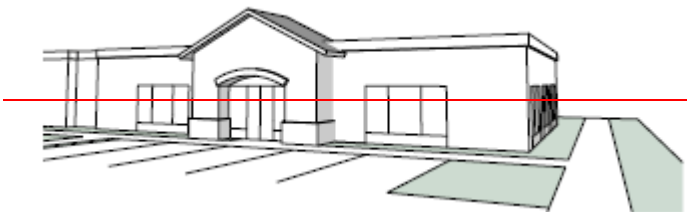

A design element incorporating a pitched roof or gable roof end.

C.—Menu of Additional Façade Expression Tools for Building Design Category D

All buildings in Building Design Category D must incorporate additional façade expression to add visual interest. One option must be selected from the following list:

1. Awning/Canopy

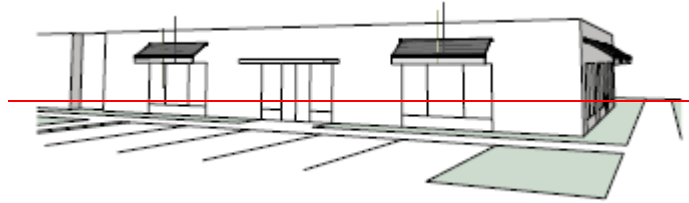

Use of an awning or canopy above transparent glass windows or other ground floor pedestrian interest areas for at least 30% of the linear façade width. (Note that these design elements may also be used to meet requirements for front-facing entry elements).

2. Arcade/Gallery/Veranda/Pergola

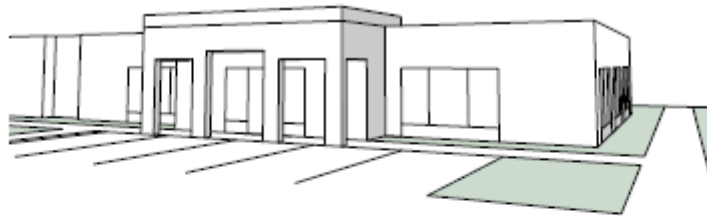

Roofed (or partially roofed), arcade, gallery, veranda or pergola elements that are not enclosed on more than two sides and extend at least 6 feet over or towards the sidewalk along at least 10% of the linear façade width, or a minimum of 30 feet (note that these design elements may also be used to meet requirements for front-facing entry elements).

3. Ornamental Cornice

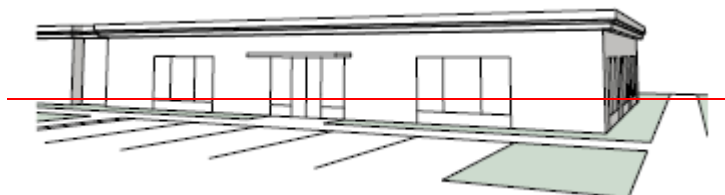

A cornice projecting a minimum of 6 inches from the primary façade at the top floor parapet level.

D. Transparent Glass on Primary Façade for Building Design Category D

See Table 15-6.

E. Menu of Ground Floor Pedestrian Interest Tools for Building Design Category D

All buildings in Building Design Category D must use transparent glass or other tools to promote pedestrian interest at the ground floor of the primary façade. A minimum of 35% of the ground floor wall area¹ on the primary façade must be covered with one or more of the following tools:

1. Transparent Glass

Window and door areas with transparent glass (also counts toward minimum transparent glass on primary façade).



2. Architectural Details

Installation of green screens or other architectural details.

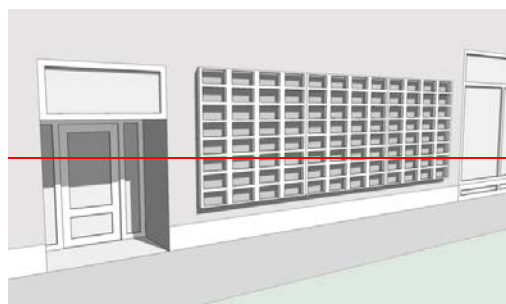

3.—Integrated Planters

Permanent planters at least 3 feet in height, attached to the ground floor of the building.

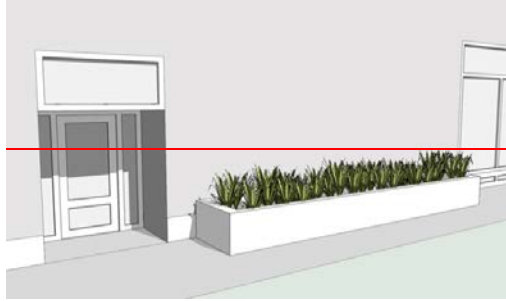

4.—Entry Elements

Entry elements from the Menu of Entry Elements for Building Design Category D.

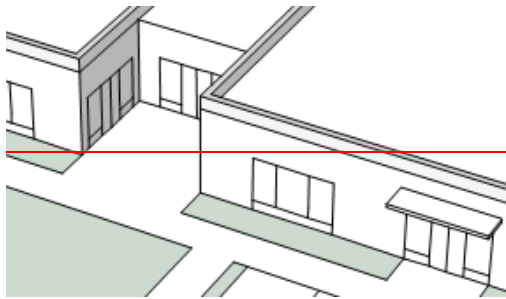

The wall area covered by planters will be calculated according to the length of façade covered by the planter.

F.— Menu of Entry Elements for Building Design Category D

All buildings in Building Design Category D must incorporate a front-facing entry element to signal the connection between the sidewalk and the building. One entry element shall be provided for each primary ground floor use in the building. An entry element shall be placed either on the primary façade, or be visible from the street. It may extend a maximum of 5 feet into the minimum front setback area. The following entry elements meet the front-facing entry requirement:

~~1.—Awning/Canopy~~

~~A horizontal projecting element cantilevered at least 4 feet from a wall or window area above the entry, and at least 10 feet above the sidewalk below. (Note that this entry option may also be used to meet requirements for additional primary façade expression).~~

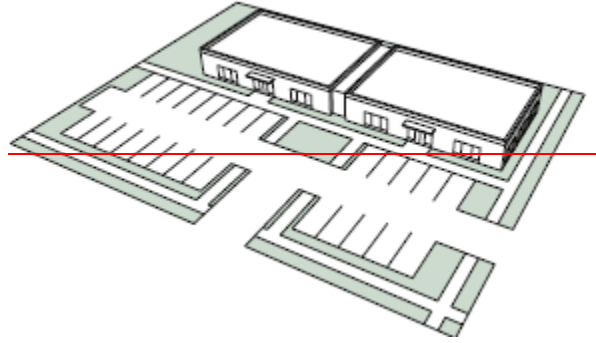

~~2.—Courtyard~~

~~A court, patio or other indentation in the building façade at least 6 feet deep—building entry doors may face onto the patio from any direction.~~

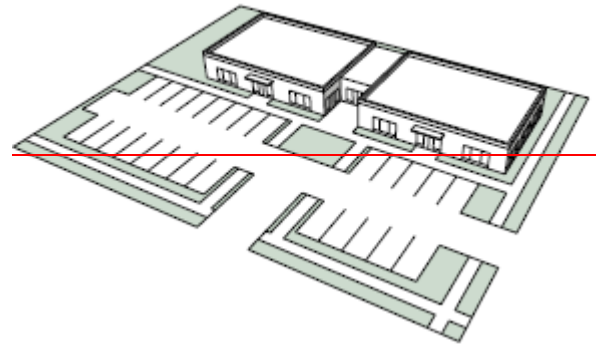

~~G.—Building Materials on Primary Façades for Building Design Category D~~

~~See Table 15-6.~~

~~H.—Building Materials on Secondary Façades for Building Design Category D~~

~~See Table 15-6.~~

~~(Building Design Category D continues on next page)~~

I.— Menu of Mixed Building Materials Options for Building Design Category D

The primary façades of all buildings in Building Design Category D must incorporate a mix of building materials. This may include a mix of materials within Materials Category 1 or within Materials Categories 1 and 2 as specified in Table 15-6. Choose at least one of the following options:

1.— Vertical Change in Materials

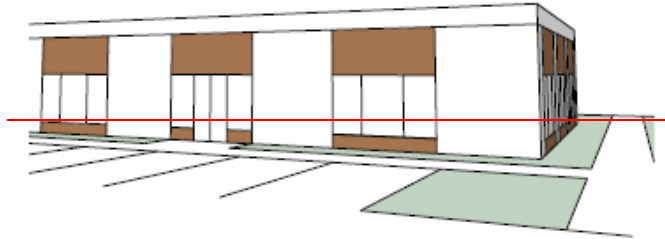

A change in materials extending a substantial portion of the height of the primary façade, creating a vertical band a minimum of every 100 feet of façade width.

2.— Horizontal Change in Materials

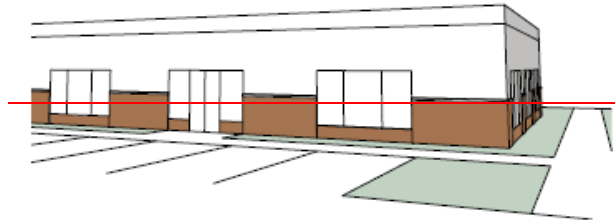

A change in materials extending a substantial portion of the width of the primary façade, creating a horizontal band between upper and lower sections of the façade.

3.— Horizontal and Vertical Change in Materials

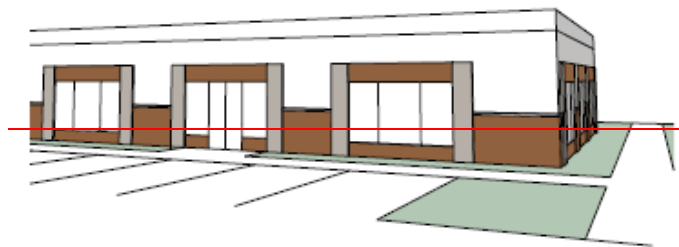

Changes in materials extending a substantial portion of the height and width of the primary façade. If this option is selected, the required percentage of materials on the primary façade

from Materials Category 1 may be reduced to 50% (with the remaining 50% chosen from Materials Category 2):

J. Transition Standard for Projects Adjacent to Single-Family Neighborhoods

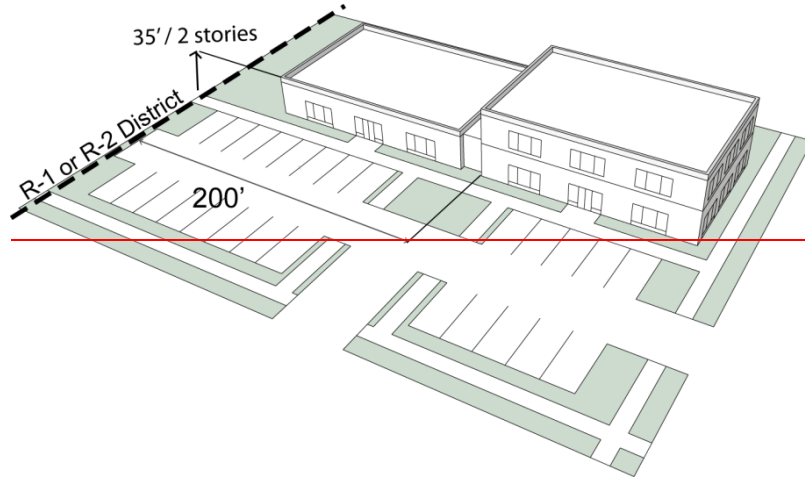

A building or portion of a building located within 200 feet of an R-1 or R-2 district may be no more than 35 feet or two stories in height.

K. Overhead Doors / Loading Docks

1. Overhead Doors or Loading Docks shall:

- a.** face the rear lot line or an alley, or
- b.** for overhead doors that face the front lot line or are visible from a public street only, include columns or similar architectural features that disguise the overhead doors by:
 - (1)** aligning along the outside edges of each overhead door, and
 - (2)** extending with the column's outside plane at least 4 feet from the primary building plane.



~~2. An overhead door or loading dock that is visible from a public street must incorporate a canopy and/or windows in the overhead doors to minimize visual impacts on the public right-of-way.~~

~~3. Overhead doors that allow only pedestrian access may face a front lot line. (Ord. 16-20 § 4, 2016)"~~

SECTION NINE: Section 18.15.045 of the Olathe Municipal Code (Unified Development Ordinance) is hereby amended to read as follows:

~~18.15.045—Building Design Category E~~

~~Composite Building Design Category E provides standards to ensure compatible development in areas designated by PlanOlathe as Employment Areas. The following design standards apply to all projects in Building Design Category E:~~

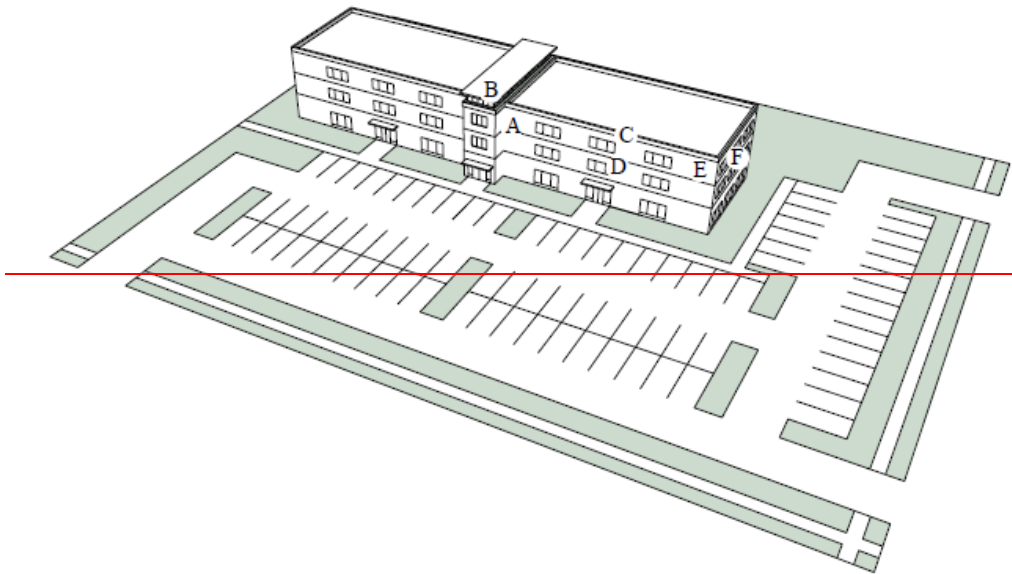

~~Table 15-7. General Building Design Standards for Building Design Category E~~

Façade Expression		
A	Horizontal and Vertical Articulation of Primary Façade	Required—See menu options
B	Focal Point Elements on Primary Façade	Required—See menu options
C	Additional Primary Façade Expression	Required—See menu options
D	Transparent glass on Primary Façades (min. %)	20%¹

Exterior Building Materials

E	Building Materials on Primary Façades (min. % Materials Category 1 / max. % Materials Category 2)	70% / 30%
F	Building Materials on Secondary Façades (min. % Materials Category 1 / max. % Materials Category 2)	50% / 50%

Transition Standards

G	Transition to R-1 and R-2 Districts	Required—See text
----------	-------------------------------------	-------------------

Overhead Doors

H	Location of Overhead Doors for Vehicular Access	May not be located on primary façade ²
----------	---	---

¹ Spandrel glass may be allowed to meet a portion of this requirement.

² Overhead doors that are not used for vehicular access may be located on a primary façade.

A. Menu of Articulation Tools for Building Design Category E

All buildings in Building Design Category E must incorporate horizontal and vertical primary façade articulation to divide building mass into human scale modules.

1. Horizontal Articulation

One or more of the following horizontal articulation tools must be used a minimum of every 100 feet of linear façade width:

a. Wall Offset

A horizontal wall plane offset of at least 4 feet, extending for the full height of the primary façade.

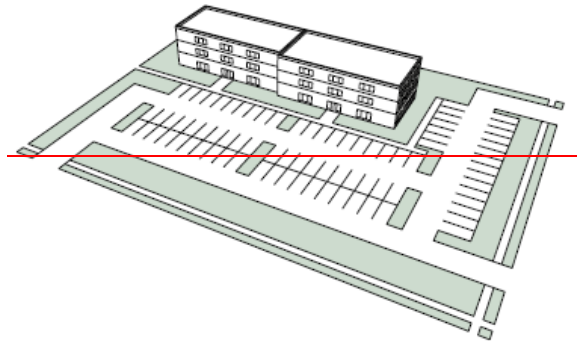

b. Wall Notch

A setback or notch in the wall plane at least 4 feet deep and 8 feet wide for the full height of the primary façade.

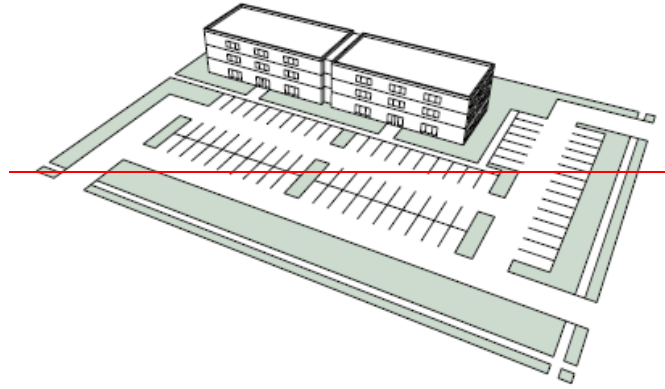

c. Wall projection

A projection or molding at least 4 inches deep and 1 foot wide for the full height of the primary façade.

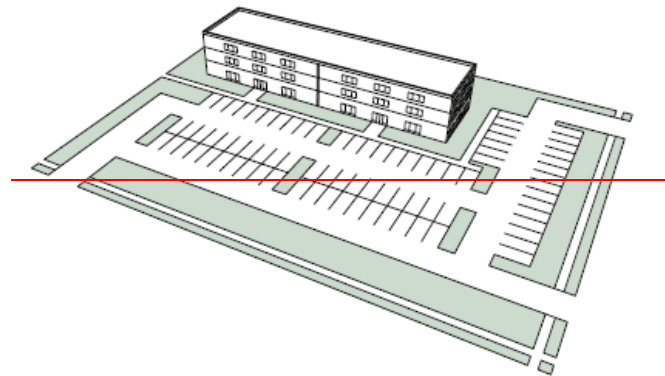

2. Vertical Articulation

One or more of the following vertical articulation tools must be used a minimum of every 100 feet of linear façade width:

a. Variation in Height as viewed from the street

A variation in building or parapet height of at least 2 feet (or 4 feet for buildings greater than two stories in height).

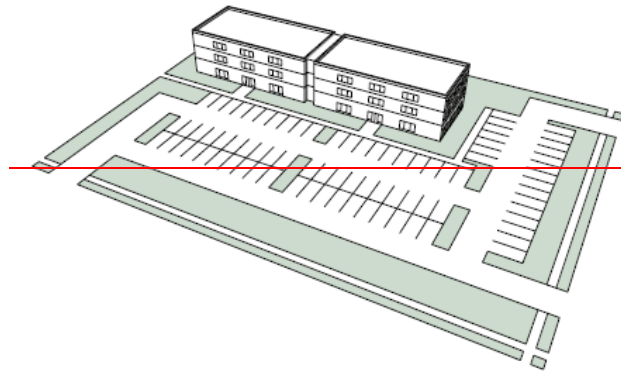

b. Variations in Roof Form

Use of more than one roof form to express different building modules.

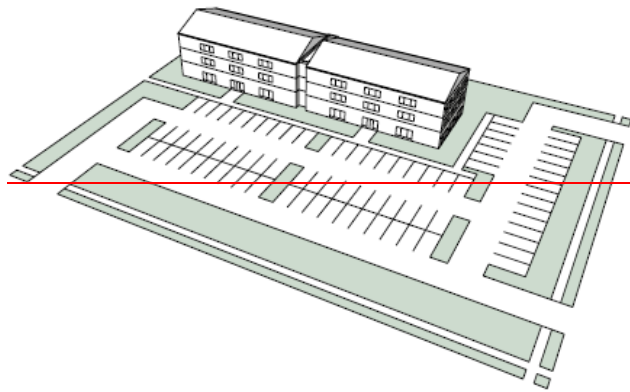

B. Menu of Focal Point Elements for Building Design Category E

All buildings in Building Design Category E must incorporate focal point design elements to help define the character of the structure. Select one or more of the following focal point design elements:

1. Tower or Raised Parapet Element

Towers or raised roof parapets that produce variations in building height of at least 4 feet and project at least 1 foot from the front and rear of the primary façade plane.

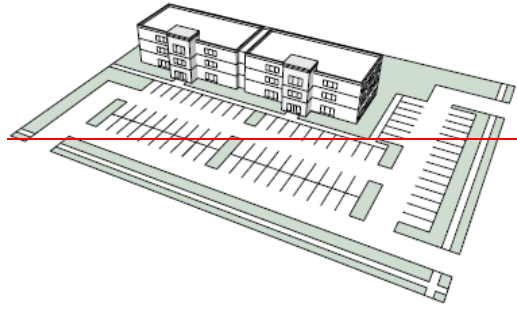

2. Cap Element

A design element projecting above the roofline and incorporating clerestory windows or other transparent areas.

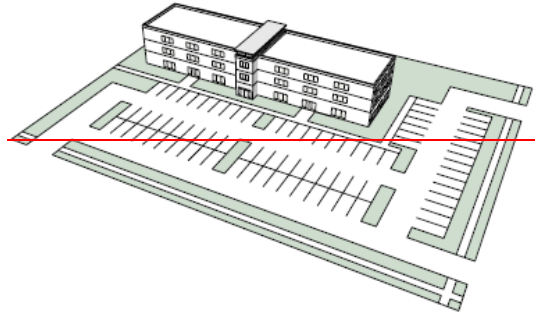

3. Pitched Roof Elements

A design element incorporating a pitched roof or gable roof end.

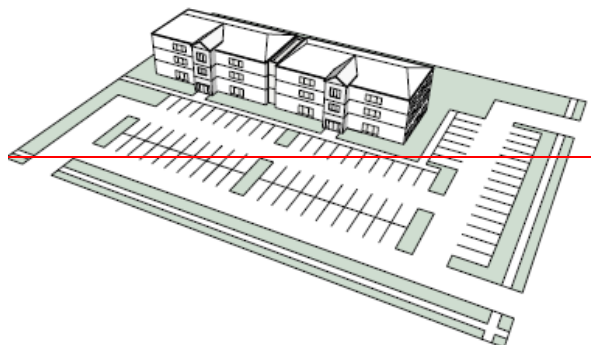

C. Menu of Additional Primary Façade Expression Tools for Building Design Category E

All buildings in Building Design Category E must incorporate additional façade expression to add visual interest. For buildings up to two stories in height, one option must be selected from the following list. For buildings over two stories in height, two options must be selected:

1. Expression Line

A horizontal projection (or combination of projections) such as a molding or series of balconies extending along at least 60% of the linear façade width above the first floor level.

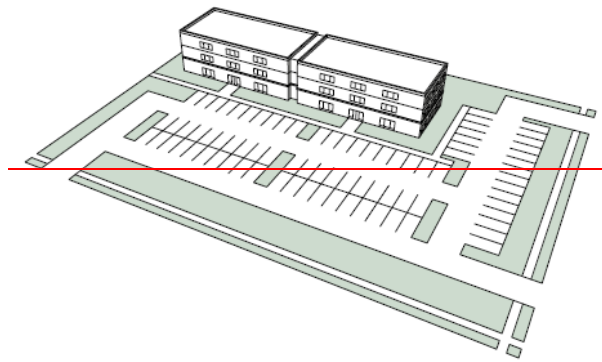

2. Change in Materials

A change in materials between lower and upper floors for the full width of the primary façade.

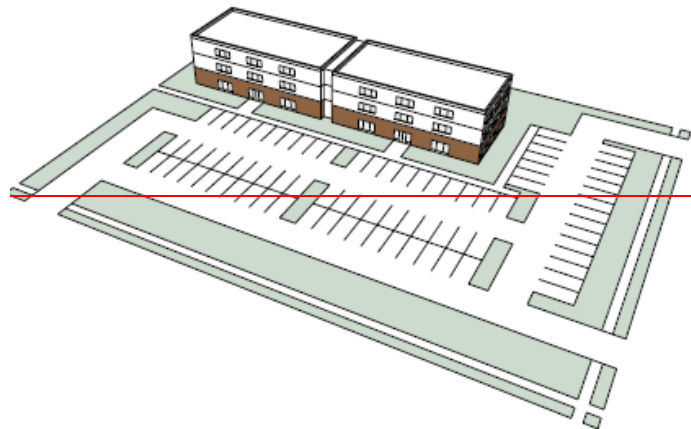

3. Arcade / Gallery / Veranda / Pergola

Roofed (or partially roofed), arcade, gallery, veranda or pergola elements that are not enclosed on more than two sides and extend at least 6 feet over or towards the sidewalk along at least 10% of the linear façade width, or a minimum of 30 feet.

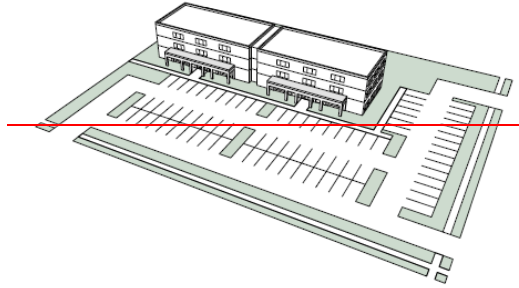

4. Ornamental Cornice

A cornice projecting a minimum of 6 inches from the primary façade at the top floor parapet level.

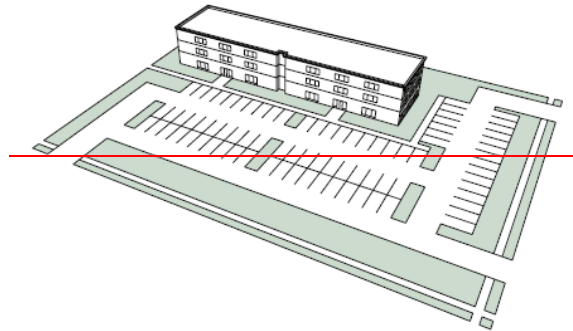

5. Increased Transparency

An increase of 20% or more in the amount of transparent glass on the primary façade.

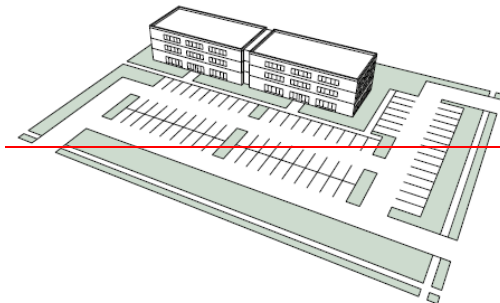

~~6. Increased Material Quality~~

~~An increase of 20% or more in use of building materials from Materials Category 1 on the primary façade or secondary façades.~~

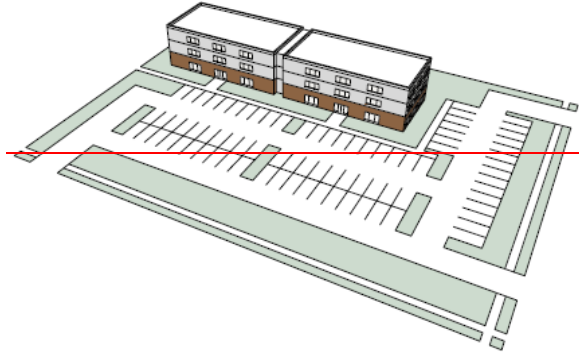

~~D. Transparent Glass on Primary Façade for Building Design Category E~~

~~See Table 15-7.~~

~~E. Building Materials on Primary Façades for Building Design Category E~~

~~See Table 15-7.~~

~~F. Building Materials on Secondary Façades for Building Design Category E~~

~~See Table 15-7.~~

~~G. Transition Standard for Projects Adjacent to Single-Family Neighborhoods~~

~~A building or portion of a building located within 200 feet of an R-1 or R-2 district may be no more than 35 feet or two stories in height.~~

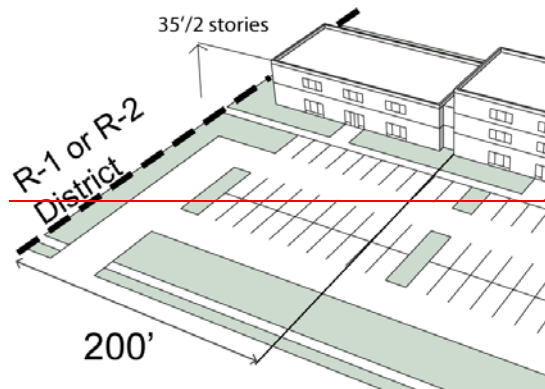

~~H. Overhead Doors / Loading Docks~~

- ~~1. Overhead Doors or Loading Docks shall:
 - ~~a. Meet the standards for Building Design Category D (see § 18.15.040.H), or~~
 - ~~b. For overhead doors only, be screened with a minimum Class 3 buffer (see § 18.30.130.J.4).~~~~
- ~~2. Overhead doors that allow only pedestrian access may face a front lot line.~~

SECTION TEN: Section 18.15.050 of the Olathe Municipal Code (Unified Development Ordinance) is hereby amended to read as follows:

~~“18.15.050 — Building Design Category F~~

~~Composite Building Design Category F provides standards to ensure compatible development in areas designated by *Plan Olathe* as Industrial areas. The following design standards apply to all projects in Building Design Category F:~~

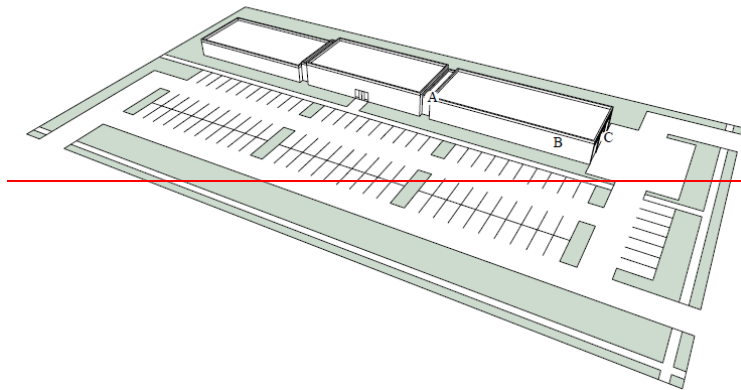

~~Table 15-8. General Building Design Standards for Building Design Category F~~

Façade Expression		
A	Primary Façade Expression	Required—See menu options
Exterior Building Materials		
B	Building Materials on Primary Façade (minimum % from Materials Category 1 / Materials Category 2 / and maximum % Materials Category 3)	20% / 60% / 20%

C	Building Materials on Secondary Façade (minimum % from Materials Category 1 or 2 / and maximum % Materials Category 3)	20% / 80%
----------	--	-----------

Transition Standards

D	Transition to R-1 and R-2 Districts	Required—See text
----------	-------------------------------------	-------------------

Overhead Doors

E	Location of Overhead Doors for Vehicular Access	Design standards apply to overhead doors located on the primary façade—See below
----------	---	--

A.—Menu of Primary Façade Expression Tools for Building Design Category F

All buildings in Building Design Category F must incorporate façade expression to add visual interest. For buildings up to two stories in height, one option must be selected from the following list. For buildings over two stories in height, two options must be selected:

1.—Wall Offset

A horizontal wall plane offset of at least 4 feet, extending for the full height of the primary façade—Offsets must occur a minimum of every 100 feet of façade width.

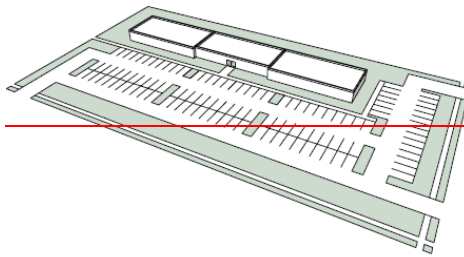

2.—Wall Notch

A setback or notch in the wall plane at least 4 feet deep and 8 feet wide for the full height of the primary façade—Notches must occur a minimum of every 100 feet of façade width.

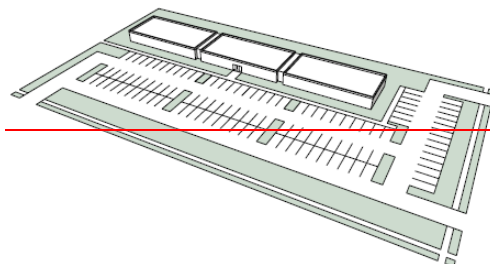

3.—Wall Projection

A projection or molding at least 4 inches deep and 1 foot wide for the full height of the primary façade—Projections must occur a minimum of every 100 feet of façade width.

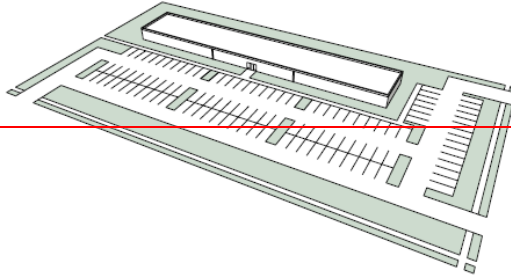

4.—Variation in Height as Viewed from the Street

A variation in building or parapet height of at least 2 feet (or 4 feet for buildings greater than two stories in height)—Variations must occur a minimum of every 100 feet of façade width.

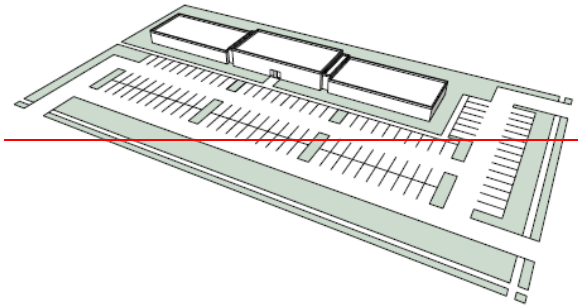

5.—Variations in Roof Form

Use of more than one roof form to express different building modules—Variations must occur a minimum of every 100 feet of façade width.

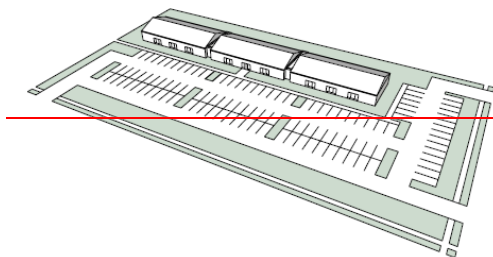

6. Ornamental Cornice

A cornice projecting a minimum of 6 inches from the primary façade at the top floor parapet.

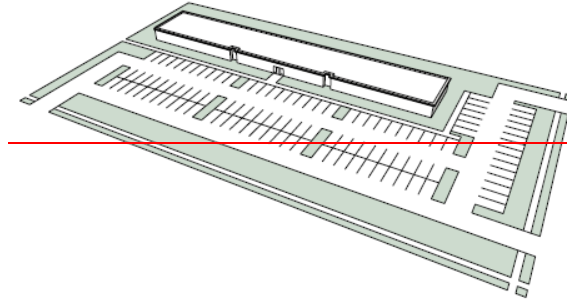

7. Transparency

A minimum 20% transparent glass on the primary façade.

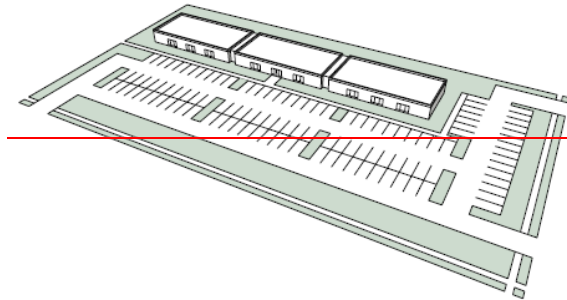

8. Increased Material Quality

An increase of 20% or more in use of building materials from Materials Category 1 or 2 on the primary façade.

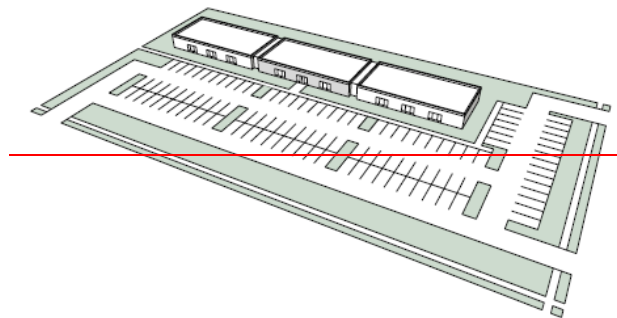

~~B.—Building Materials on Primary Façades for Building Design Category F~~

~~See Table 15-8.~~

~~C.—Building Materials on Secondary Façades for Building Design Category F~~

~~See Table 15-8.~~

~~D.—Transition Standard for Projects Adjacent to Single-Family Neighborhoods~~

~~A building or portion of a building located within 200 feet of district R-1 or R-2 may be no more than 35 feet or two stories in height.~~

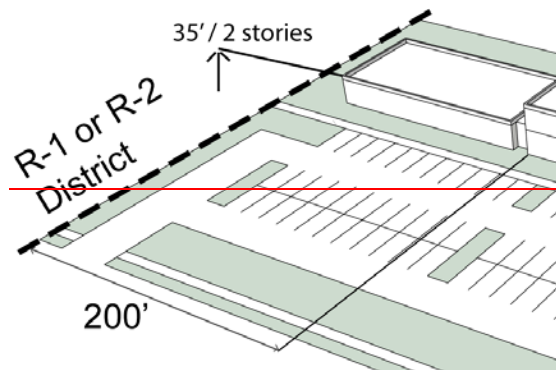

~~E.—Overhead Doors / Loading Docks~~

~~Overhead Doors or Loading Docks shall:~~

~~Meet the standards for Building Design Category D (see § 18.15.040.H) or a minimum 2 feet tall clerestory window positioned on or above the door or a 3-foot deep canopy above the overhead door, and~~

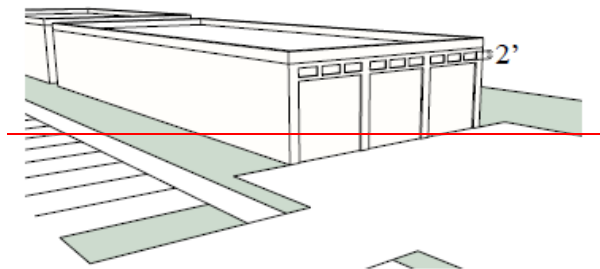

- ~~1.— If facing a public street or residential zoning district, incorporate a minimum Class 4A buffer (see § 18.30.130.J.4).~~

~~(Ed. Note Section 18.15.060 through 18.15.090 reserved) —(Ord. 15-16-53, 2015)~~

SECTION ELEVEN: Section 18.15.020 of the Olathe Municipal Code (Unified Development Ordinance) is hereby amended to read as follows:

“18.15.020 Building Design Standards

A. Purpose and Intent.

The intent of this Chapter is to establish building design standards that enhance the general appearance, maintain, and improve the quality of life for residents and visitors, and protect the value of properties within the City of Olathe. Building design and construction of all buildings, including residential and nonresidential buildings, will have features that are integrally designed, employing quality design principals and building materials that are long-lasting and harmonious to adjoining properties and the community.

All buildings will employ recognized architectural styles and design principals on all sides (four-sided architecture) and be proportional, with elements in scale, and designed with a top, middle, and bottom. For example, buildings with three (3) or more stories in height should have masonry or stone (heavy) bases and generally have low-slope roofs with heavy cornices versus pitched, residential style roofs that may be out-of-scale with the building. Building exterior materials must be applied in an authentic and honest manner reflecting the material’s purpose, weight, and typical use in order to convey a sense of strength and durability.

The architectural design of single-family residences, their materials and color, must be visually harmonious with the overall appearance of the community, natural environment, and other quality development existing in the City. The exterior appearance of single-family residences must consist of complimentary building materials and design features that provide a variation in amenities and features and incorporate high-quality standards into the building layout, open space, natural topography, sustainability practices and overall character. The visual elements and amenities will be proportional to the relationships and patterns of the built and natural environment while providing decorative detailing and utilizing high-quality materials.



Examples of quality architectural styles and design principles

B. Applicability

The standards within this Chapter will apply to all new buildings, additions, expansions, remodels, and renovations of existing buildings within the jurisdiction of the City of Olathe. Separate architectural standards for buildings in the Downtown District (Section 18.20.210) and the Original Town Overlay District (Section 18.20.280) will apply to developments within those Districts in addition to those in this Chapter.

For standards pertaining to screening of trash and recycling enclosures, building and rooftop mounted mechanical, and utility equipment, see Section 18.30.130.

For standards pertaining to lighting, see Section 18.30.135.

C. Definitions

The terms and phrases used in this section are defined as follows:

Architectural Features – Physical additions to a structure that allow the creation of different styles including, but not limited to, porches, balconies, dormers, bay windows, shutters, belvederes, chimneys, colonnades, towers, cupolas, cornices, eaves, soldier courses, lintels, and decorative ornaments.

Awning – A roof-like cover designed and intended for protection from weather or as a decorative embellishment, and which projects from a wall or roof of a structure over a window, walk, door, or similar feature.

Building Elevation – A flat, scale drawing of the front, rear, or side of a building.

Building Facadism – The application of false or fake building façades or elements over an existing building façade or roof.

Cornice – Overhang of a pitched roof.

Façade Area – The total exterior wall area of all vertical or near-vertical faces of a building wall four (4) feet in width or greater. ~~when viewed in elevation.~~ Façade area will be calculated to include the area of parapets, cornices, and similar wall extensions and trim. Façade area will be calculated to exclude the wall area resulting from minor projections and recessions from the predominant wall plane less than four (4) feet in depth.

Façade or Face – The exterior wall of a building exposed to public view or that wall viewed by persons not within the building.

Major Façade Materials – Exterior finish materials that cover at least 5% of a building's façade area. Any material that covers less than 5% of a building façade area will not be considered a "major" façade material and will not count towards meeting any requirement for use of multiple Class 1, 2, or 3 materials.

Primary Façade – Means all street-facing façades (i.e., all building façades that face or front along a public or private street including highways), and façades with a building's main customer entrance. Buildings may have more than one primary façade as is the case with buildings located on corner lots and double frontage lots. All other façades will be "secondary" façades.

Street Facing Façade – Means all building façades that have frontage along or face a public or private street (does not include private drives) at an angle of 45 degrees or less from the street line. This definition includes those building façades separated from the street by a parking lot or open space.

D. Building Additions

The building design standards provided in this Chapter apply to all additions to existing buildings. Additions to a building that was approved subject to these building design standards must meet or exceed the building design standards contained within this Chapter. For exceptions building additions constructed prior to this Ordinance, see Section 18.60.020.F. Buildings constructed under the standards of this Ordinance, exceptions may be granted by the Planning Official to ensure that building additions are aesthetically compatible with the existing building design.

The regulations of this Chapter do not apply to building façade maintenance and repair including repainting of existing painted surfaces, window or siding material replacement with identical or similar materials, and roof replacement with identical or similar materials.

E. General Requirements

Subsections 1 through 6 below apply to all buildings except for Agricultural and Single-Family Detached Residential building types as stated in Section G of this Chapter.

1. Building Facadism – Building facadism, defined as the application of false or fake building façades or elements over an existing building façade or roof, is discouraged. Windows or dormers should be in proportion with and match the adjoining roof pitch and have the

appearance of being functional and operational. Hip or mansard roofs that only partially conceal a roof well or low slope roof area are also discouraged. Roof parapets and roof top screen walls must have returns along the sides to conceal the edges.



Examples of Building Facadism

2. Application of Exterior Building Materials –

- a. A distinctly different color of fired clay brick (full brick or brick veneer) may be considered as an additional Class 1 or Class 2 material for the purposes of meeting the required minimum number of different major façade materials.
- b. Heavy exterior materials, such as any type of brick and stone, must be applied to acknowledge its historic use as a building foundation and structure material. Brick or stone that appears to be unsupported or 'float' within a façade will not be permitted, e.g., stone applied to a roof dormer.



Inappropriate application of stone over brick



Appropriate application of brick over

- c. Exterior finishes of brick and stone will not be painted, except as approved by the Planning Official.
- d. EIFS is not to be used within ten (10) feet of the finished floor elevation of the façade on which it is located.

e. Thin brick and stone veneer, when utilized, must comply with the following:

- (1) Thin brick and stone veneer will only be used in applications where the actual brick or stone thickness will not be distinguishable or is otherwise addressed by adjustments in the wall plane to provide the appearance of full depth brick or real stone.
- (2) 'L' shaped brick corner pieces and full-depth brick caps must be utilized at all corners and edges to maintain the appearance of full-depth brick.
- (3) Thin brick and stone veneer must be continued (returned) a minimum of 12-inches around wall corners to further maintain the appearance of full-depth brick or real stone.



Inappropriate application of thin brick veneer Appropriate application of thin brick veneer

3. Use of Trim on Primary Façades – Except where architecturally unsuitable, appropriately scaled trim of at least three (3) inches in width must be included around all window and door openings, building corners, roof lines, and façade material transitions located on primary façades.

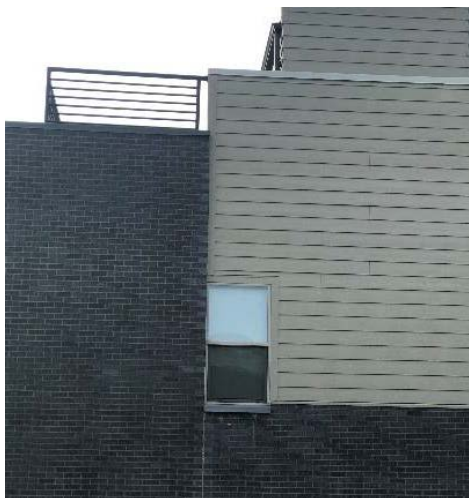

Example of window missing trim



Example of appropriate use of trim

4. Shutters – If used, shutters must be in scale with the adjoining opening and be operational or have the appearance of being operational and functional as a true shade or shutter. Each shutter must be equal to the height, and one-half (1/2) the width of the adjoining opening and must be paired with a matching shutter on the opposite side of the opening, or alternatively, a single shutter must be equal to both the height and width of the adjoining opening.



Example of out-of-scale shutters



Example of appropriately scaled shutters

5. Soffits, Overhangs, and Cornices – All building soffits, overhangs, and cornices must be appropriately scaled with a typical projection of no less than six (6) inches, except as may be appropriate based on the architectural style.



Examples of appropriately scaled cornices and overhangs

6. Franchise Architecture – Franchise colors and exterior finish materials may be utilized subject to compliance with the design regulations contained within this Chapter.
7. Accessory Building Standards – Accessory buildings in all non-residential zoning districts must comply with the building design requirements for the principal building of the lot

the accessory building is located on. Supplemental regulations for garages, carports, and sheds are located in Section 18.50.060. For regulations for residential districts, see Section 18.50.060, and Sections F.4 and F.5 of this Chapter. Temporary and small movable structures, including ATMs and donation boxes, are exempt from these standards.

8. Awnings and Canopies – The following standards will apply to awnings and canopies for all buildings, excluding Agricultural, Single-Family Detached Residential, and Two-Family Residential building types as stated in Section G of this Chapter.

a. Attached awnings and canopies that are located on a primary façade or are visible from the street must:

(1) Be in proportion to the wall area or the opening it is covering and be of an appropriate pedestrian scale and height; and

(2) Use non-vinyl materials that are durable in the local climate such as commercial grade fabric, canvas, tile, slate, architectural quality metal, or similar materials. Asphalt or composition shingle, or other materials with a synthetic or plastic appearance are not allowed; and

(3) Use materials with a matte finish; and

(4) Use a single color or two (2) color stripes; and

(5) Be placed within, rather than overlapping, the vertical elements of a building façade that is divided into distinct structural bays; and

(6) Not be internally illuminated.



Example of appropriate attached canopies

- b. Freestanding canopies, including but not limited to canopies over gas pumps or drive-through services must be integrated into the roof design of the principal structure or incorporate roof shapes or massing similar to the principal structure.

(1) All exterior canopy surfaces must:

- a. Be made with materials from Classes 1, 2, or 3 (see Table 18.15.020-1), that are compatible with the principal structure, and
- b. Have a matte finish.

(2) Canopy columns must:

- a. Be clad primarily in masonry with materials from Classes 1, 2, or 3 (see Table 18.15.020-1), that are compatible with the principal structure, and
- b. Be a minimum 18 inches in width.

(3) The use of strips or bands of neon light are prohibited.



Example of a gas station canopy following design of primary building

9. Gutters and Downspouts – The following standards will apply to all buildings (not including Agricultural, Single-Family Detached Residential, Two-Family Residential, and Horizontally Attached Residential building types as stated in Section G of this Chapter).

- a. The location and design of exposed gutters and downspouts must be identified on building elevations submitted for approval.

- b. Exposed gutters and downspouts must be constructed of high-quality, commercial-grade metal, and must be painted to be compatible with the color of the building.
- c. Exposed gutters and downspouts on primary façades are prohibited. Exceptions may be granted by the Planning Official, for downspouts that are designed by the building architect as decorative architectural elements that are an integral component of the building design and coordinated with vertical elements such as towers, columns, or pilasters.

F. Building Exterior Finish Materials

For the purposes of this Chapter, exterior building materials are categorized into four (4) different quality classes in Table 18.15.020-1. Class 1 materials are considered “very high-quality” materials, Class 2 materials are considered “high-quality” materials, and Class 3 are considered “standard quality” materials. Class 4 materials are considered “limited use” materials for minor trim elements.

The Approving Authority may recategorize any building material listed in Table 18.15.020-1, or may categorize a building material not included within Table 18.15.020-1 for an individual project if it finds that the material is similar or of higher quality to the other materials in the same category with regard to:

1. Durability and quality; and
2. Appearance; and
3. Sustainability practices; and
4. Compatibility with the architectural style of the buildings that are subject to the application for approval.

Table 18.15.020-1 - Permitted Building Finish Materials by Materials Class

	Class 1	Class 2	Class 3	Class 4	Definitions
Masonry and Stone (Non-load bearing)					
Brick veneer, fired clay	✓				Fired clay brick, full-veneer masonry wall system
Brick veneer (thin), fired clay		✓			Thin veneer fired clay brick adhered to a wall surface or wall anchoring system, with the appearance of full brick
Brick paneling, fired clay			✓		Prefabricated panels of thin veneer fired clay brick
Brick veneer, synthetic		✓			Synthetic bricks adhered to wall surface or wall anchoring system
Brick paneling, synthetic			✓		Prefabricated panels of synthetic brick adhered to a wall surface or wall anchoring system
Stone veneer, natural	✓				Genuine stone, full-veneer masonry wall system
Stone paneling, natural		✓			Prefabricated panels of genuine stone adhered to wall surface or wall anchoring system
Stone veneer, synthetic	✓				Synthetic stone adhered to wall surface or wall anchoring system
Stone paneling, synthetic		✓			Prefabricated panels of synthetic stone adhered to a wall surface or wall anchoring system
Stucco, genuine	✓				Traditional Portland cement based stucco applied in 3 coats over a solid surface
	Class 1	Class 2	Class 3	Class 4	Definitions
Concrete Masonry Units					
Burnished/ground-faced block		✓			Concrete modular blocks, smooth finish with large aggregates visible or polished finish and with mortared joints
Patterned or shaped block		✓			Concrete modular blocks, face surface has pattern or shape, not flat, and with mortared joints
Split-faced block			✓		Concrete modular blocks, rough, split-faced finish, and with mortared joints
Plain, flat-faced block				✓	Concrete modular blocks, plain, flat finish, and with mortared joints

	Class 1	Class 2	Class 3	Class 4	Definitions
Concrete					
Architectural quality precast concrete panels	✓				Highest finish precast concrete panels, textured or burnished, and integrally colored - not painted
Cast-in-place concrete, board formed or decorative form liner		✓			Architecturally designed cast-in-place concrete with a high-quality patterned or textured surface created by board forms or decorative concrete form liners
Cast-in-place concrete, plain			✓		Textured or smooth finish, may be painted
Site cast and precast concrete panels			✓		Site cast and precast concrete panels, plain, smooth finish, may be painted
	Class 1	Class 2	Class 3	Class 4	Definitions
Metal					
Architectural quality, composite metal wall panel systems	✓				High quality insulated metal panels for decorative surface application, such as <i>Alucobond panel systems</i>
Architectural quality metal wall panel systems, concealed fastening			✓		High quality metal panels for decorative surface application with concealed fasteners, such as <i>Firestone Delta</i>
Architectural quality metal wall panel systems, exposed fastening			✓		High quality metal panels for decorative surface application with exposed fasteners, such as <i>Firestone Omega</i>
Metal (panels, siding, and trim)				✓	Standard metal siding and panels, painted or coated for exterior application
	Class 1	Class 2	Class 3	Class 4	Definitions
Glass					
Clear glass (windows, curtain walls, paneling systems)	✓				Clear glass with no visible tint, reflective coating, coloring, or other covering (not including low-e or UV coatings or treatments)
Glass blocks			✓		Hollow translucent block of varying shapes and sizes made entirely from glass. Also, known as glass brick.

Mirrored glass				✓	Glass with a reflective or mirrored coating or finish
Opaque or tinted glass (including color applied)			✓		Glass with a tinted or colored coating or finish or otherwise treated to produce a tint that reduces its opacity.
Spandrel Glass		✓			Opaque glass panels with a fire-fused ceramic frit paint; typically used between vision areas of windows to conceal structural columns floors and shear walls
	Class 1	Class 2	Class 3	Class 4	Definitions
Other Materials					
Wood (panels and siding)			✓		Authentic hardwood or exterior rated, rot-resistant wood paneling and siding
Cement fiber board (panels and siding)			✓		Cement panels reinforced with cellulose fibers, such as <i>HardiePlank</i> and <i>HardiePanel</i>
Exterior Insulation and Finish System (EIFS)			✓		Polystyrene foam covered with a synthetic stucco, water-managed and exterior rated
Composite wood (panels, siding, and trim)				✓	Composite or other synthetic wood types, such as <i>LP SmartSide</i>
Vinyl and PVC (panels, siding, and trim)				✓	Exterior siding and trim that is made from a synthetic resin or plastic.
Ceramic			✓		Ceramic tile adhered to a wall surface or wall anchoring system
Translucent wall panel systems			✓		Panels or blocks, typically hollow, made of translucent polycarbonate material - such as <i>Kalwall</i>
Fabric					(not permitted)
	Class 1	Class 2	Class 3	Class 4	Definitions
Roofing Materials					
Standing Seam Metal	✓				Vertically run metal panels connected within interlocking raised seams
Metal roof panel system		✓			High quality metal panels designed for roof application
Metal panel				✓	Standard metal roof panels, designed for roof application

Slate	✓				Natural stone tiles (or shingles) cut from slate, traditionally applied in an overlapping pattern
Tile	✓				Fired clay, ceramic, or concrete roofing tiles applied in an overlaying pattern
Synthetic or composite slate		✓			Molded plastic to mimic the appearance of slate tiles
Green roof	✓				Low-slope roof covered with roof-top plants in a designed roof-top planting system
Simulated metal roofing		✓			Membrane roofing system designed with the appearance of a standing seam metal roof
Membrane or ballast (not visible)		✓			Typical roofing materials for low-slope roofs and is not visible from any adjacent public or private street or residential developed or zoned properties
Membrane or ballast (visible)				✓	Typical roofing materials for low-slope roofs
Asphalt shingles (laminated or dimensional)		✓			Asphalt shingles constructed with a heavy base mat and multiple adhered layers to provide a thicker, dimensional appearance - also known as laminated architectural shingles
Asphalt shingles (3-tab)			✓		Asphalt shingles constructed with a single layer of material and 3 cut shingle "tabs"
Glass roofing	✓				A roof constructed of glass panels or glass tiles within a glass framing system - also known as a roof glazing system
Fabric				✓	Exterior rated fabric designed for application in a canopy or roofing system

G. Building Design Standards by Building Type

For the purposes of this Chapter, all buildings will be categorized by building use type, as listed below. Any building type not listed, or any question as to the appropriate categorization of a building will be as reviewed by the Planning Official. Building design standards are regulated by both building use type and the zoning district in which the building is located.

Building Types

1. **Agricultural Building:** this includes, but is not limited to, buildings located in the Agricultural District, park picnic shelters, buildings used for agricultural purposes, silos, and greenhouses:
2. **Single-Family Detached Residential:** this includes, but is not limited to, Modular Homes, Accessory Dwellings, Bed and Breakfasts, and Group Homes (does not include manufactured homes, see Section 18.50.100).

3. **Two-Family Residential:** Duplexes
4. **Horizontally Attached Residential:** this includes, but is not limited to, Townhomes, Rowhouses, Triplexes, Fourplexes.
5. **Vertically Attached Residential:** this includes, but is not limited to, Apartments, Condos, Rooming Houses, Live-Work Units, Community Living, Homeless Shelter, Assisted Living, Skilled Care Facilities, and Continuing Care Retirement Facilities.
6. **Non-Residential Building in Residential Zoning District:** this includes, but is not limited to, Schools, Religious Institutions, Places of Assembly, Community Centers, Community Food and Personal Support Services, Cultural Facilities, Funeral Homes and Mortuaries, Libraries, Public Facilities, and Governmental Buildings.
7. **Commercial or Retail Building:** this includes, but is not limited to, Single and Multi-Tenant Commercial Buildings, Day Care Centers, Restaurants, Financial Institutions, Hotels, Motels, and Recreational and Entertainment Buildings.
8. **Office and Civic Building:** this includes, but is not limited to, Single and Multi-Tenant Office Buildings and, when in non-residential zoning districts, Schools, Religious Institutions, Places of Assembly, Community Centers, Community Food and Personal Support Services, Cultural Facilities, Funeral Homes and Mortuaries, Libraries, Public Facilities, and Governmental Buildings.
9. **Mixed-Use Building:** a building developed for two (2) or more different uses including, but not limited to, residential, office, manufacturing, retail, or public uses.
10. **Industrial Building:** (M-1, M-2, or M-3 zoning required)

Building Type Standards

1. Agricultural Buildings

- a. Agricultural buildings are not subject to minimum building façade treatment requirements.

2. Single-Family Detached Residential

- a. Single-Family Detached Residential buildings constructed on lots larger than 7,200 square feet are not subject to minimum building façade treatment requirements.

- b. Single-Family Detached Residential buildings constructed on lots 7,200 square feet or smaller must comply with the following building design standards:

(1) Building Design Elements

All buildings must incorporate a front-facing entry element to signal the connection between the sidewalk and the house. An entry element must be placed either on the primary façade or be visible from the street. It may extend a maximum of (five) (5) feet into the minimum front setback area, not including stairs or landings. The following entry elements meet the front-facing entry requirement:

- (a) Front Porch - A roofed but unenclosed entry element with a minimum width of eight (8) feet and depth of four (4) feet - Partial walls or railings may be no more than four (4) feet tall.
- (b) Side Entry - A roofed but unenclosed entry element with a minimum depth of four (4) feet projecting from a side-facing doorway.
- (c) Recessed Entry - An entry recessed at least two (2) feet into the primary façade.

(2) Garage Door Options

Buildings that are less than two (2) stories in height must have garage doors that are subordinate to the primary façade to minimize visual impacts and encourage pedestrian orientation. Select at least one of the following options:

- (a) Front-Facing Garage Door with Limited Width - Front-facing garage door(s) extending a maximum of 50% of the primary façade width or 28 feet, whichever is greater.
- (b) Garage Door Set Back from Primary Façade - Front-facing garage door(s) set back at least five (5) feet from the primary façade.
- (c) Side or Rear Facing Garage Doors - Garage door(s) oriented perpendicular to the street or facing the opposite direction from the street.

(3) Primary façades must use a minimum of 70% Single-Family Class A Materials and a maximum 30% Single-Family Class B Materials as listed in Table 18.15.020-2 below.

Table 18.15.020-2: Single-Family Residential Building Materials

Single-Family Class A	Single-Family Class B
Brick, Solid	Brick, Panel/Veneer
Brick, Modular	Stucco, Synthetic/Panels
Stone, Modular	Concrete, Plain Finish
Stone, Veneer	Concrete Masonry Unit, Split Faced
Stone, Synthetic	Cement Fiber Board
Stucco, Genuine, Detailed	Architectural Metal
Concrete, Detailed	Architectural Block (Glass)
Concrete Masonry Unit, Burnished	Mirror Glass
Clear Glass	Opaque Glass
Architectural Panels (Glass)	Wood, Other Synthetics
	Synthetic Stucco/EIFS (Detail Only)



Examples of High-Quality Design Single-Family Detached Residential Structures

3. Two-Family Residential

a. Building Façade Treatment

(1) Front Porch or Recessed Entryway

- (a) All buildings must have a front porch or recessed front entryway along at least one (1) primary façade for each unit.
- (b) The porch or recessed entry must be covered, a minimum of four (4) feet in depth, and a minimum six (6) feet in width.

(2) Garages

- (a) The maximum projection of a street-facing garage from the primary façade (front) line will be two (2) feet. Exceptions may be granted by the Planning Official, to allow projections greater than two (2) feet.
- (b) Any garage with three (3) or more stalls must be recessed a minimum of two (2) feet from the front line of the adjoining the first and second garage stalls.

b. Exterior Building Materials

- (1) Primary façades must use no less than two (2) different Class 1 building finish materials on no less than 70% of the surface area.
- (2) Secondary façades must use no less than two (2) different Class 1 building finish materials on no less than 20% of the surface area.

c. Roofing Materials - Must use Class 1, 2, or 3 roofing materials.

4. Horizontally Attached Residential

a. Building Façade Treatment

(1) Front Porch or Recessed Entryway

- (a) Each unit must have its own front porch or recessed front entryway along one primary façade.
- (b) The porch or recessed entry must be covered, a minimum of four (4) feet in depth, and a minimum six (6) feet in width.

(2) Garages

- (a) All street-facing garages must be recessed a minimum of two (2) feet from the building primary façade (front) line.
- (b) Any garage with three (3) or more stalls must be recessed a minimum of two (2) feet from the front line of the adjoining the first and second garage stalls.

(3) Windows

- (a) No less than two (2) separate windows must be provided for each dwelling unit along all primary façades. Each window must be no less than six (6) square feet in size.
- (b) The primary façade of any accessory building must have no less than two (2) windows or other architectural features for every 50 linear feet of wall façade.

(4) Façade Articulation

Each primary façade must be divided into vertical bays to identify each individual dwelling unit width. Façade bays must be differentiated from the adjoining units through a combination of horizontal and vertical wall articulation including changes to the design of the individual entryway, changes to the roofline, and through the use of differing exterior finish materials and colors.



Examples of horizontally attached residential buildings with appropriate façade articulation

One or more of the following façade articulation techniques for each of the following categories must be used on each individual dwelling unit width along all primary façades.

(a) Horizontal Articulation

- i. Wall Offset - the offset of the horizontal wall plane by at least four (4) feet extending for the full height of the primary façade.
- ii. Wall Notch - a setback or notch in the horizontal wall plane that is at least four (4) feet deep and eight (8) feet wide for the full height of the primary façade.
- iii. Wall Projection - a projection or wall molding that is at least four (4)-inches deep and one (1) foot wide for the full height of the primary façade.

(b) Vertical Façade Articulation

- i. Variation in Height - the variation in building or parapet height of at least two (2) feet or four (4) feet for buildings greater than two (2) stories in height.
- ii. Variation in Roof Form - the use of a different roof form, such as changes in roof pitch.

b. Exterior Building Materials

(1) Primary Façades

- (a) Must use no less than two (2) different Class 1 building finish materials on no less than 70% of the surface area.
- (b) Class 4 materials must not be incorporated on more than 5% of any primary façade.

(2) Secondary Façades

- (a) Must use no less than two (2) different Class 1 building finish materials on no less than 50% of the surface area.
- (b) Class 4 materials must not comprise more than 5% of any secondary façade.

c. Roofing Materials - Must use only Class 1 or 2 roofing materials.

5. Vertically Attached Residential

a. Building Façade Treatment

- (1) Deck, Patio, or Rooftop Area - Each dwelling unit must have its own deck, balcony, or patio (minimum 24 square feet in size), or access to a finished roof-top amenity deck located within the same building. The Approving Authority may approve, a well-finished outdoor amenity space as an acceptable alternative. This provision does not apply to senior housing facilities.

(2) Building Entryway

- (a) Elevated open walkways and stairways along the exterior of the building are prohibited.

- (b) All common building entries must be defined by being covered by a projection from the façade or by being recessed.

(3) Garage Doors (Attached Garages)

- (a) Any street-facing garage doors must be recessed a minimum of two (2) feet from the building primary façade (front) line.
- (b) Street-facing garage doors must be architecturally treated and include an archway, column, awning, or overhang.

(4) Freestanding Garages, Carports and Parking Structures

- (a) The design for any freestanding garages, carports, or parking structures must comply with the façade articulation and exterior building materials requirements for a primary structure and must be compatible with the design of the primary buildings on site.



Example of a detached garage compatible with the design of the primary building

- (b) All garage and overhead doors and parking bays must face the interior of the site and must not be visible from an arterial roadway.
- (c) The primary façade of any accessory structure must have no less than two (2) separate windows for every 50 linear feet of wall façade. Each window must be no less than four (4) square feet in size.

(5) Façade Articulation

Each primary façade must be divided into vertical bays that are no greater than 50 feet in width. Façade bays must be differentiated from the adjoining units through a combination of horizontal and vertical wall articulation including changes to the design of the individual entryway, changes to the roofline, and through the use of differing exterior finish materials and colors.



Example of façade bay and articulation



No façade bays or articulation

One or more of the following façade articulation techniques for each of the following categories must be used on every 50 feet of façade width along all primary façades:

(a) Horizontal Articulation

- i. Wall Offset - the offset of the horizontal wall plane by at least four (4) feet extending for the full height of the primary façade.
- ii. Wall Notch - a setback or notch in the horizontal wall plane that is at least four (4) feet deep and eight (8) feet wide for the full height of the primary façade.
- iii. Wall Projection - a projection or wall molding that is at least four (4) inches deep and one (1) foot wide for the full height of the primary façade.

(b) Vertical Façade Articulation

- i. Variation in Height - the variation in building or parapet height of at least two (2) feet or four (4) feet for buildings greater than two (2) stories in height.
- ii. Variation in Roof Form - the use of a different roof form, such as changes in roof pitch.

(6) Façade Expression

- a. The primary façades of all buildings two (2) or more stories in height must incorporate one or more of the following façade expression techniques:
 - (1) Expression Line - a horizontal projection (or combination of projections) such as a molding or series of balconies extending along at least 60% of the primary façade width above the first-floor level.
 - (2) Change in Material - a change in the building façade materials between lower and upper floors for the full length of the primary façade.
 - (3) Awning or Canopy - the use of an awning or canopy above clear glass windows for at least 60% of the primary façade width.



Example of appropriate use of façade expression

b. Exterior Building Materials

(1) Primary Façades

(a) Must use no less than three (3) different Class 1 building finish materials on no less than 70% of the surface area of each primary façade with a minimum of 20% clear glass.

(b) Class 4 materials must not comprise more than 5% of any primary façade.

(2) Secondary Façades

a. Must use either two (2) materials from Class 1 or a combination of two (2) materials from Class 1 and Class 2 on no less than 50% of the façade with a minimum of 10% clear glass.

b. Class 4 materials must not comprise more than 5% of any secondary façade.

c. Roofing Materials - Must use only Class 1 or 2 roofing materials.

6. Non-Residential Buildings in Residential Zoning Districts

Non-residential buildings (includes, but is not limited to, religious institutions and schools) that are permitted in residential zoning districts are subject to the following standards.

a. Building Façade Treatment

(1) Building Entryway - The main common building entry must be defined with a covered projection from the façade or by a recessed area.

(2) Façade Articulation

Each primary façade must be divided into vertical bays no greater than 50 feet in width. Façade bays must be differentiated from the adjoining units through a combination of horizontal and vertical wall articulation including changes to the design of the individual entryway, changes to the roofline, and through the use of differing exterior finish materials and colors.

One or more of the following façade articulation techniques for each of the categories listed below must be used every 50 feet of façade width along all primary façades:

(a) Horizontal Articulation

- i. Wall Offset - the offset of the horizontal wall plane by at least four (4) feet extending for the full height of the primary façade.
- ii. Wall Notch - a setback or notch in the horizontal wall plane that is at least four (4) feet deep and eight (8) feet wide for the full height of the primary façade.
- iii. Wall Projection - a projection or wall molding that is at least four (4) inches deep and one (1) foot wide for the full height of the primary façade.

(b) Vertical Façade Articulation

- i. Variation in Height - the variation in building or parapet height of at least two (2) feet or four (4) feet for buildings greater than two (2) stories in height.
- ii. Variation in Roof Form - the use of a different roof form, such as changes in roof pitch.



Examples of non-residential buildings with vertical and horizontal façade articulation

The primary façades of all buildings two (2) or more stories in height must incorporate one or more of the following façade expression techniques:

- (a) Expression Line - a horizontal projection (or combination of projections) such as a molding or series of balconies extending along at least 60% of the primary façade width above the first-floor level.
- (b) Change in Material - a change in the building façade materials between lower and upper floors for the full length of the primary façade.
- (c) Awning or Canopy - the use of an awning or canopy above clear glass windows for at least 60% of the primary façade width.
- (d) Ornamental Cornice - a cornice projecting a minimum of 12 inches from the primary façade at the top floor parapet level for at least 60% of the linear façade width.

b. Exterior Building Materials

(1) Primary Façades

- (a) Must use either three (3) materials from Class 1 or a combination of three (3) materials from Class 1 and Class 2 on no less than 75% of the façade with a minimum of 20% clear glass.
- (b) Class 4 materials must not comprise more than 5% of any primary façade.

(2) Secondary Façades

- (a) Must use either two (2) materials from Class 1 or a combination of two (2) materials from Class 1 and Class 2 on no less than 50% of the façade.
- (b) Class 4 materials must not comprise more than 5% of any secondary façade.

c. Roofing Materials - Must use only Class 1 or 2 roofing materials.

7. Commercial or Retail Buildings

a. Building Façade Treatment

(1) Building Entryway - Each building entry along all primary façades must be defined with a covered projection from the façade or by a recessed area.

(2) Garages and Overhead Doors

(a) Garages and overhead doors must not face a public street.

(b) If visible from a public street, the garage and overhead doors must be recessed a minimum of four (4) feet from the building façade line and be architecturally treated with a combination of glass windows, archways, columns, canopies, or overhangs.

(3) Façade Articulation

Each primary façade must be divided into vertical bays that are no greater than 50 feet in width. Façade bays must be differentiated from the adjoining units through a combination of horizontal and vertical wall articulation including changes to the design of the individual entryway, changes to the roofline, and through the use of differing exterior finish materials and colors.

One or more of the following façade articulation techniques for each of the following categories must be used on every 50 feet of façade width along all primary façades:

(a) Horizontal Articulation

i. Wall Offset - the offset of the horizontal wall plane by at least four (4) feet extending for the full height of the primary façade.

ii. Wall Notch - a setback or notch in the horizontal wall plane that is at least four (4) feet deep and eight (8) feet wide for the full height of the primary façade.

- iii. Wall Projection - a projection or wall molding that is at least four (4) inches deep and one (1) foot wide for the full height of the primary façade.

(b) Vertical Façade Articulation

- i. Variation in Height - the variation in building or parapet height of at least two (2) feet or four (4) feet for buildings great than two (2)-stories in height.
- ii. Variation in Roof Form - the use of a different roof form, such as changes in roof pitch.



Examples of commercial retail buildings with appropriate vertical and horizontal articulation

(4) Façade Expression

- (a) The minimum height for all one (1) story principal buildings must be 17 feet and the minimum first floor height of all multi-story principal buildings must be 11 feet.
- (b) Buildings less than three (3) stories in height must include one (1) tower element or similar special vertical articulation to anchor the main entry or building corner.
- (c) The primary façades of all buildings two (2) or more stories in height must incorporate one or more of the following façade expression techniques:

- i. Expression Line - a horizontal projection (or combination of projections) such as a molding or series of balconies extending along at least 60% of the primary façade width above the first-floor level.
- ii. Change in Material - a change in the building façade materials between lower and upper floors for the full length of the primary façade.
- iii. Awning or Canopy - the use of an awning or canopy above clear glass windows for at least 60% of the primary façade width.
- iv. Ornamental Cornice - a cornice projecting a minimum of 12 inches from the primary façade at the top floor parapet level for at least 60% of the linear façade width.

b. Exterior Building Materials

(1) Primary Façades

- (a) Must use either three (3) materials from Class 1 or a combination of three (3) materials from Class 1 and Class 2 on no less than 80% of the façade with a minimum of 25% clear glass on the first floor and 30% clear glass on the upper floors.
- (b) Class 4 materials must not comprise more than 5% of any primary façade.

(2) Secondary Façades

- (a) Must use either three (3) materials from Class 1 or a combination of three (3) materials from Class 1 and Class 2 on no less than 50% of the façade.
- (b) Class 4 materials must not comprise more than 5% of any secondary façade.

c. Roofing Materials - Must use only Class 1 or 2 roofing materials.

8. **Office Buildings**

a. Building Façade Treatment

(1) Building Entryway

Each building entry along all primary façades must be defined with a projection from the façade or a recessed area.

(2) Façade Articulation

Each primary façade must be divided into vertical bays that are no greater than 75 feet in width. Façade bays must be differentiated from the adjoining units through a combination of horizontal and vertical wall articulation including changes to the design of the individual entryway, changes to the roofline, and through the use of differing exterior finish materials and colors.

One or more of the following façade articulation techniques for each of the following categories must be used on every 75 feet of façade width along all primary façades:

(a) Horizontal Articulation

- i. Wall Offset - the offset of the horizontal wall plane by at least four (4) feet extending for the full height of the primary façade.
- ii. Wall Notch - a setback or notch in the horizontal wall plane that is at least four (4) feet deep and eight (8) feet wide for the full height of the primary façade.
- iii. Wall Projection - a projection or wall molding that is at least four (4) inches deep and one (1) foot wide for the full height of the primary façade.

(b) Vertical Façade Articulation

- i. Variation in Height - the variation in building or parapet height of at least two (2) feet or four (4) feet for buildings greater than two (2) stories in height.

- ii. Variation in Roof Form - the use of a different roof form, such as changes in roof pitch.



Examples of office buildings with appropriate vertical and horizontal articulation

(4) Façade Expression

- (a) The minimum height for all one (1) story principal buildings must be 17 feet and the minimum first floor height of all multi-story principal buildings must be 11 feet.
- (b) Buildings less than three (3) stories in height must include one tower element or similar special vertical articulation to anchor the main entry or building corner.
- (c) The primary façades of all buildings two (2) or more stories in height must incorporate one or more of the following façade expression techniques:
 - i. Expression Line - a horizontal projection (or combination of projections) such as a molding or series of balconies extending along at least 60% of the primary façade width above the first-floor level.
 - ii. Change in Material - a change in the building façade materials between lower and upper floors for the full length of the primary façade.
 - iii. Awning or Canopy - the use of an awning or canopy above clear glass windows for at least 60% of the primary façade width.
 - iv. Ornamental Cornice - a cornice projecting a minimum of 12 inches from the primary façade at the top floor parapet level for at least 60% of the linear façade width.

b. Exterior Building Materials

(1) Primary Façades

- (a) Must use either two (2) materials from Class 1 or a combination of two (2) materials from Class 1 and Class 2 on no less than 70% of the façade with a minimum of 25% clear glass.
- (b) Class 4 materials must not comprise more than 5% of any primary façade.

(2) Secondary Façades

- (a) Must use either two (2) materials from Class 1 or a combination of two (2) materials from Class 1 and Class 2 on no less than 50% of the façade with a minimum of 15% clear glass.
- (b) Class 4 materials must not comprise more than 5% of any secondary façade.

c. Roofing Materials - Must use only Class 1 or 2 roofing materials.

9. Mixed-Use Buildings

a. Building Façade Treatment

- (1) Deck, Patio, or Rooftop Area - Each dwelling unit must have its own deck or patio (minimum 24 square feet in size), or access to a finished roof-top amenity deck located within the same building.

(2) Building Entryway

- (a) First floor, primary façades must be pedestrian oriented with a combination of street-facing entries, clear glass store-front windows, awnings, or overhangs.
- (b) Individual, first floor building entries along all primary façades must be covered by a projection from the façade or be recessed.

(c) Elevated open walkways along the exterior of the building are prohibited.

(d) The main common building entry must be defined by being covered by a projection from the façade or by being recessed.

(3) Garage and Overhead Doors

(a) Garage and overhead doors should not face a public street.

(b) If visible from a public street, the garage and overhead doors must be recessed a minimum of four (4) feet from the building façade line and be architecturally treated with a combination of glass windows, archways, columns, canopies, or overhangs.

(4) Windows

(a) First floor primary façades must incorporate a minimum 35% clear glass.

(b) Upper floor primary façades must incorporate a minimum 20% clear glass.

(c) All secondary façades must incorporate a minimum 15% clear glass.

(5) Façade Articulation

Each primary façade must be divided into vertical bays that are no greater than 50 feet in width. Façade bays must be differentiated from the adjoining units through a combination of horizontal and vertical wall articulation including changes to the design of the individual entryway, changes to the roofline, and through the use of differing exterior finish materials and colors.



Examples of mixed-use buildings with appropriate vertical and horizontal articulation

One or more of the following façade articulation techniques for each of the following categories must be used on every 50 feet of façade width along all primary façades:

(a) Horizontal Articulation

- i. Wall Offset - the offset of the horizontal wall plane by at least four (4) feet extending for the full height of the primary façade.
- ii. Wall Notch - a setback or notch in the horizontal wall plane that is at least four (4) feet deep and eight (8) feet wide for the full height of the primary façade.
- iii. Wall Projection - a projection or wall molding that is at least four (4) inches deep and one (1) foot wide for the full height of the primary façade.

(b) Vertical Façade Articulation

- i. Variation in Height - the variation in building or parapet height of at least two (2) feet or four (4) feet for buildings greater than two (2) stories in height.
- ii. Variation in Roof Form - the use of a different roof form, such as changes in roof pitch.

(6) Façade Expression

- (a) The minimum height for all one (1) story principal buildings must be 17 feet and the minimum first floor height of all multi-story principal buildings must be 11 feet.
- (b) Buildings less than three (3) stories in height must include one tower element or similar special vertical articulation to anchor the main entry or building corner.
- (c) The primary façades of all buildings two (2) or more stories in height must incorporate one or more of the following façade expression techniques:

- i. Expression Line - a horizontal projection (or combination of projections) such as a molding or series of balconies extending along at least 60% of the primary façade width above the first-floor level.
- ii. Change in Material - a change in the building façade materials between lower and upper floors for the full length of the primary façade.
- iii. Awning or Canopy - the use of an awning or canopy above clear glass windows for at least 60% of the primary façade width.
- iv. Ornamental Cornice - a cornice projecting a minimum of 12 inches from the primary façade at the top floor parapet level for at least 60% of the linear façade width.

b. Exterior Building Materials

(1) Primary Façades

- (a) Must use no less than three (3) different Class 1 building finish materials on no less than 80% of the surface area of each primary façade with a minimum of 35% clear glass on the first floor and 20% clear glass on the upper floors.
- (b) Class 4 materials must not comprise more than 5% of any primary façade.

(2) Secondary Façades

- (a) Must use either three (3) materials from Class 1 or a combination of three (3) materials from Class 1 and Class 2 on no less than 60% of the façade with a minimum of 15% clear glass.
- (b) Class 4 materials must not comprise more than 5% of any secondary façade.

c. Roofing Materials - Must use only Class 1 or 2 roofing materials.

10. Industrial Buildings

a. Building Façade Treatment

- (1) Building Entryway - The main common building entry must be defined with a projection from the façade or a recessed area.
- (2) Garage and Overhead Doors - Garage and overhead doors may only face a local or collector public street, unless completely screened from view. If visible, street facing doors must include a three (3) foot deep canopy or overhang above the doorway, are recessed a minimum of two (2) feet from the building façade line, and the door is architecturally treated.
- (3) Windows - First floor primary façade areas must incorporate a minimum 15% clear glass.
- (4) Façade Articulation

Each primary façade must be divided into vertical bays that are no greater than 50 feet in width for buildings less than 100,000 square feet in size and 100 feet in width for buildings 100,000 square feet and greater in size. Façade bays must be differentiated from the adjoining units through a combination of horizontal and vertical wall articulation including changes to the design of the individual entryway, changes to the roofline, and through the use of differing exterior finish materials and colors.

Buildings less than three (3) stories in height must include tower elements or similar special vertical articulation to bookend the building or to anchor the main entry or building corner.

One or more of the following façade articulation techniques for each of the following categories must be used on every vertical bay width (as required above) along all primary façades:

(a) Horizontal Articulation

- i. Wall Offset - the offset of the horizontal wall plane by at least four (4) feet extending for the full height of the primary façade.
- ii. Wall Notch - a setback or notch in the horizontal wall plane that is at least four (4) feet deep and eight (8) feet wide for the full height of the primary façade.
- iii. Wall Projection - a projection or wall molding that is at least four (4) inches deep and one (1) foot wide for the full height of the primary façade.

(b) Vertical Articulation

- i. Variation in Height - the variation in building or parapet height of at least four (4) feet.
- iv. Variation in Roof Form - the use of a different roof form, such as changes in roof pitch.

b. Exterior Building Materials

(1) Primary Façades

- (a) Must use either two (2) materials from Class 1 or a combination of two (2) materials from Class 1 and Class 2 on no less than 75% of the façade with a minimum of 15% clear glass on the first floor.
- (b) Class 4 materials must not comprise more than 25% of any primary façade.

(2) Secondary Façades

- (a) Must use either two (2) materials from Class 1 or a combination of two (2) materials from Class 1, Class 2, or Class 3 on no less than 40% of the façade.
- (b) Class 4 materials must not comprise more than 50% of any secondary façade.

c. Roofing Materials

(1) Must use only Class 1, 2, or 3 roofing materials.

(2) Accessory structures not visible from a public street or adjoining residentially zoned or developed property may utilize Class 4 roofing materials.”

SECTION TWELVE: Section 18.15.100 of the Olathe Municipal Code (Unified Development Ordinance) is hereby amended to read as follows:

18.15.100 Composite Site Design Standards

A range of **composite** site design categories are provided to promote compatibility with surrounding land uses and community features, while providing realistic and flexible standards for new development. ~~The site design categories that apply to an area are designated on the zoning Future Land Use map.~~ Some site design categories are intended to promote design character and quality that are compatible with abutting features and neighborhoods (such as a key corridor or residential neighborhood), while other areas are intended to promote maximum design flexibility. ~~The range of design standards that apply in each site design category are briefly summarized in the table below. This summary table is for reference purposes only; the applicable design standards are detailed the remainder of this Chapter.~~

The table below establishes the site design categories for a development based upon its location on the Future Land Use Map in *PlanOlathe*. If the proposed land use does not align with *PlanOlathe*, the zoning district for the property will be used to determine the applicable site design category.

Table 15-9. Summary of Composite Site Design Standards

	1	2	3	4	5	6
Future/Proposed Land Use Map Category	Conventional Neighborhood	Conservation/Cluster Neighborhood	Neighborhood Center, Urban Center, TOD, Mixed Use Residential Neighborhood	Commercial Corridor, Regional or Community Commercial Center	Employment Area	Industrial Area
Typical Zoning District	R-1	R-1	N, C-1, D, R-2, R-3, R-4	C-2, C-3, C-4	O, BP, M-1	M-2, M-3
Open Space	Moderate amount of landscaping (perimeter only)	High level of passive open space oriented around natural features	Open space primarily provided as patios and courtyards + Limited urban landscaping to promote pedestrian orientation and reduce visual impacts of parking	Some open space provided as patios and courtyards + Significant landscaping to reduce visual impacts of parking and enhance community image	Significant perimeter landscaping to enhance community image	Significant perimeter landscaping where adjoining other uses
Building Placement	Buildings located to allow for front and rear yards	Buildings clustered to preserve open space	Buildings located near the sidewalk edge	Buildings located near the sidewalk edge or set back	Buildings located to allow for front yards	Buildings set back from the sidewalk edge
Parking	No special considerations	No special considerations	Parking located to the rear or side of buildings in small modules / Quantity limited	Parking set back from the sidewalk edge in landscaped lots / Sufficient quantity	Parking set back from the sidewalk edge in landscaped lots / Sufficient quantity	Parking set back from the sidewalk edge / Sufficient parking
Pedestrian Circulation	Sidewalks and paths provide connections	Trails and paths provide connections	Buildings are connected to the street and transit / Sidewalks and paths connect to greenways and neighborhoods	Buildings are connected to the street and transit / Sidewalks and paths connect to greenways and neighborhoods	Paths and sidewalks connect buildings and parking	No special considerations
Vehicular	Streets provide	No special	Narrow drive	Moderate drive	No special	Adequate drive

	1	2	3	4	5	6
Future/Proposed Land Use Map Category	Conventional Neighborhood	Conservation/Cluster Neighborhood	Neighborhood Center, Urban Center, TOD, Mixed Use Residential Neighborhood	Commercial Corridor, Regional or Community Commercial Center	Employment Area	Industrial Area
Typical Zoning District	R-1	R-1	N, C-1, D, R-2, R-3, R-4	C-2, C-3, C-4	O, BP, M-1	M-2, M-3
Circulation	sufficient connectivity	considerations	lanes / limited curb cuts / Off-street connections between parcels	lanes / limited curb cuts / Off-street connections between parcels	considerations	lanes for trucks / limited curb cuts
Drainage	Provides site amenities	Integrated with natural open space	Provides site amenities	Provides site amenities	Provides site amenities	No special considerations
Buffer Area	Landscape buffer adjacent to other land uses	Landscape buffer adjacent to other land uses	Landscape buffer or setback adjacent to existing single-family at perimeter of the development or Centers	Landscape buffer adjacent to single-family	Landscape buffer adjacent to single-family	Wide landscape buffer adjacent to single-family

SECTION THIRTEEN: Section 18.15.105 of the Olathe Municipal Code (Unified Development Ordinance) is hereby amended to read as follows:

“18.15.105 Site Design Category 1

~~Composite~~ Site Design Category 1 provides standards to ensure compatible site development in areas designated by *PlanOlathe* as Conventional Neighborhoods. The following ~~general~~ site design standards apply to all projects in Site Design Category 1: [The letters illustrated on Figure 1 below correspond with the site design standards provided within this Section.](#)

Figure 1: Site Design Category 1



Table 15-10. General Design Standards for Site Design Category 1

Connectivity		
A	Pedestrian Connections	Required—See menu options
B	Street Connections	Required for development with more than 25 lots—See § 18.30.220
Buffer Area Adjacent to Other Uses		
C	Landscaped buffer area adjacent to arterial streets or non-residential uses	Required—See design options

A. Menu of Pedestrian Connection Options for Site Design Category 1

Individual homes in Site Design Category 1 must be connected to the surrounding pedestrian network using one of the following options methods:

1. Public Sidewalk Connection

A walkway or driveway from a residence that connects directly to a public sidewalk.

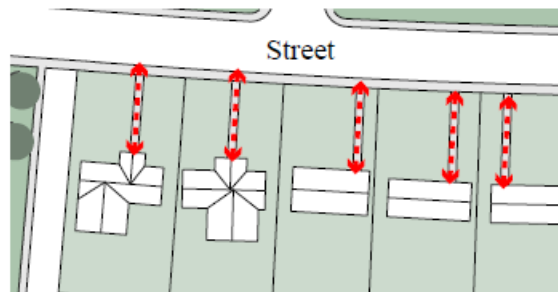

2. Internal Path to a Public Sidewalk

A walkway within a development that leads directly to a public sidewalk on the perimeter.

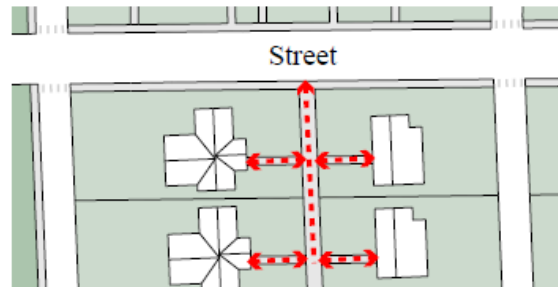

B. ~~Design Standards for Street Connectivity in Site Design Category 1~~

See § [18.30.220](#) for street connectivity and design requirements [for development with more than 25 lots](#).

C. ~~Required Landscaped Buffer Area for Site Design Category 1~~

Buffer standards apply to development in Site Design Category 1 ~~that is~~ [when](#) located adjacent to any arterial street or any non-residential zoning district. Standards are intended to promote a pedestrian-friendly edge to the development and enhance community image. One of the following landscaping strategies must be used within the required minimum setback area on the edges of a residential site adjacent to an arterial street or any non-residential zoning district. ~~For additional landscaping standards see § 18.30.130.~~

1. Planted Buffer with No Fence or Wall

A landscaped area that is at least 10 feet deep with a minimum of 70% porous/permeable surfaces and 50% planted material.

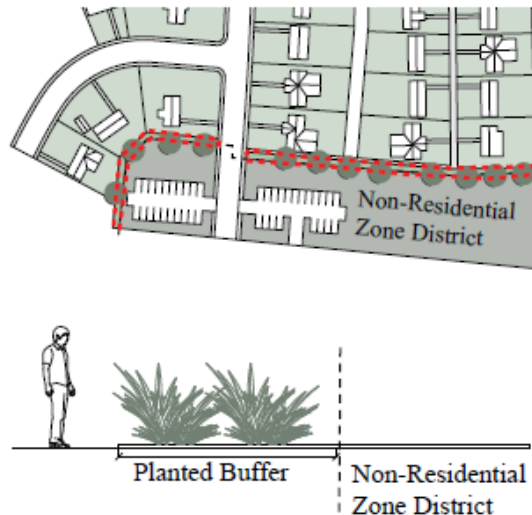

2. Planted Buffer with a Fence or Wall

A landscaped area that is at least 7 feet deep with a minimum of 70% porous/permeable surfaces and 50% planted material. A fence or wall ~~shall~~must be located within the landscape area and ~~should~~ include posts, columns, and/or pedestrian gateways a minimum of every 100 feet. (↔ See § [18.50.050](#) for fence height and design).

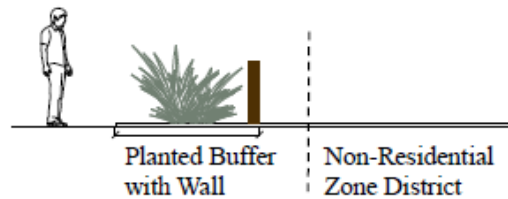

3. Street-facing Yard

A landscaped area between the public sidewalk and the front(s) of residences that is a minimum of 20 feet deep.

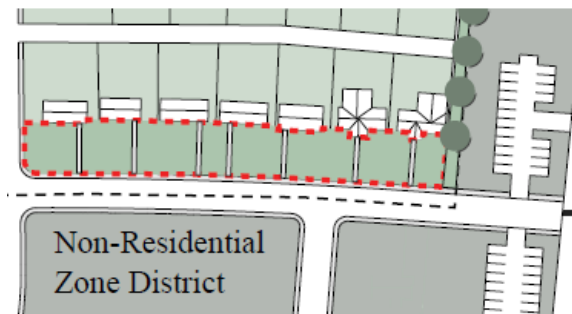

SECTION FOURTEEN: Section 18.15.110 of the Olathe Municipal Code (Unified Development Ordinance) is hereby amended to read as follows:

“18.15.110 Site Design Category 2

Composite Site Design Category 2 provides standards to ensure compatible site development in areas designated by *PlanOlathe* as Conservation Neighborhoods. The following **general** site design standards apply to all projects in Site Design Category 2. [The letters illustrated on Figure 1 below correspond with the site design standards provided within this Section.](#)

Figure 1: Site Design Category 2



Table 15-11. General Design Standards for Site Design Category 2

Open Space		
A	Common Open Space	Required—See menu options
Connectivity		
B	Pedestrian Connections	Required—See menu options
C	Street Connections	Required—See menu options
Buffer Area Adjacent to Other Uses		
D	Landscaped buffer area adjacent to arterial streets or non-residential uses	Required—See design options

A. **Menu of Common Open Space Options for Site Design Category 2**

Development in Site Design Category 2 must provide common open space areas to provide for natural resource protection and recreational opportunities for residents. ~~Select~~, using at least two of the following ~~tools~~ methods:

1. **Natural Area**

A stand of mature trees, shrubs or bushes and/or natural features such as rock outcroppings, hills or other viewpoints.

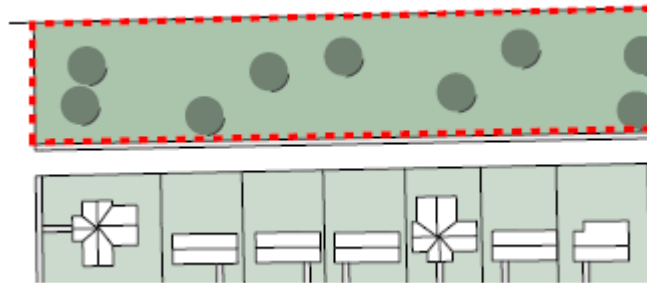

2. **Common Green Area**

A common green space shared by neighboring ~~hood residents~~ property owners that may include a lawn, a stand of trees, or shrubs.

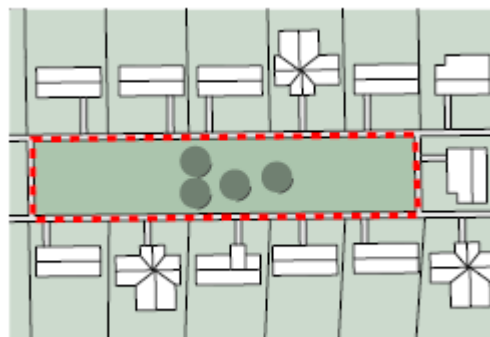

3. Natural Drainage Area

Natural streams, lakes, ponds and other drainage areas with indigenous plants, native rocks and other features (note that artificial drainage areas meeting the standards for Design of Open

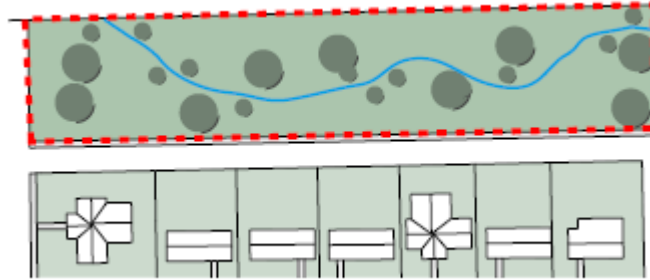

Storm Drainage and Detention Areas may also be used to meet common open space standards).

B. ~~Menu of Pedestrian Connection Options~~ for Site Design Category 2

Individual homes in Site Design Category 2 must be connected to the surrounding pedestrian network and open space system using one of the following ~~options~~ [methods](#):

1. Public Sidewalk Connection

A walkway or driveway from a residence that connects directly to a public sidewalk.

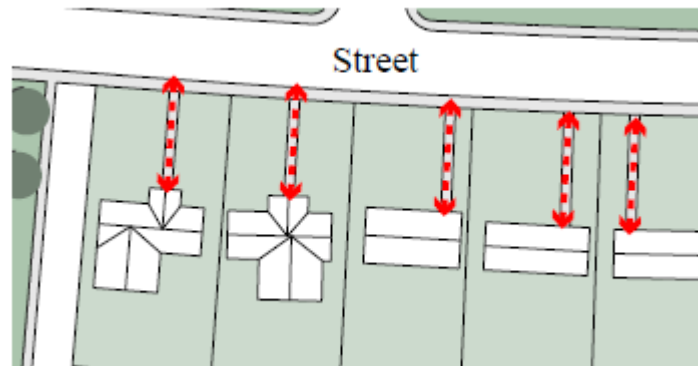

2. Connection to Common Open Space

A walkway from a residence that connects directly to common open space such as a natural area or common [green area](#).

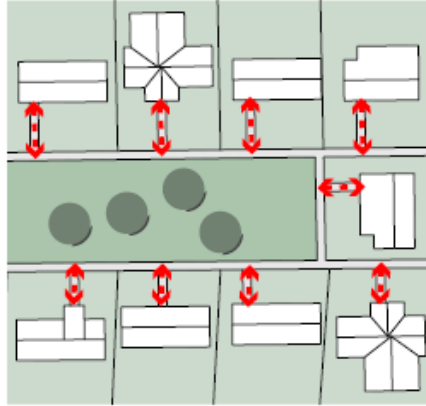

3. Internal Path to a Public Sidewalk

A walkway within a development that leads directly to a public sidewalk on the perimeter.

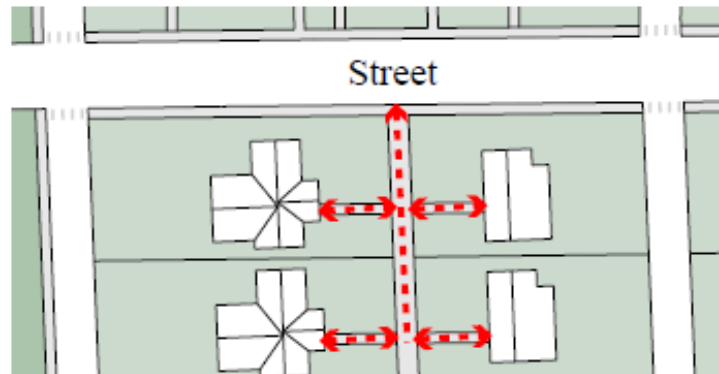

C. ~~Design Standards for~~ Street Connectivity in Site Design Category 2

Development using Site Design Category 2 is not subject to the connectivity ratio requirements, but is subject to the street standards in § [18.30.220](#).

D. Required Landscaped Buffer Area for Site Design Category 2

Buffer standards apply to development in Site Design Category 2 ~~that is~~ [when](#) located adjacent to any arterial street or any non-residential zoning district. Standards are intended to promote a pedestrian-friendly edge to the development and enhance community image. One of the following landscaping strategies must be used within the required minimum setback area on the edges of a residential site adjacent to an arterial street or any non-residential zoning district. [For additional landscaping standards See § 18.30.130.](#)

1. Planted Buffer with No Fence or Wall

A landscaped area that is at least 10 feet deep with a minimum of 70% porous/permeable surfaces and 50% planted material.

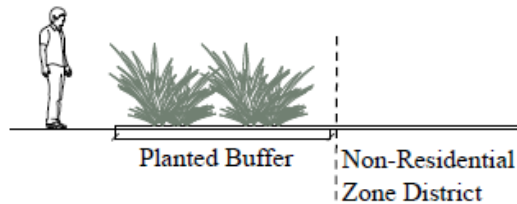

2. Planted Buffer with a Fence or Wall

A landscaped area that is at least 7 feet deep with a minimum of 70% porous / permeable surfaces and 50% planted material. A fence or wall ~~shall~~ must be located within the landscape area and ~~should~~ include posts, columns, and/or pedestrian gateways a minimum of every 100 feet. (↔ See § [18.50.050](#) for fence height and design).

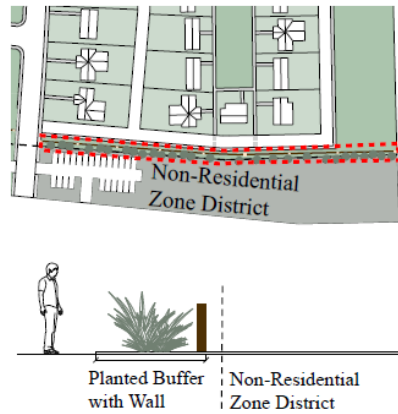

3. Street-facing Yard

A landscaped area between the public sidewalk and the front(s) of residences that is a minimum of 20 feet deep.”

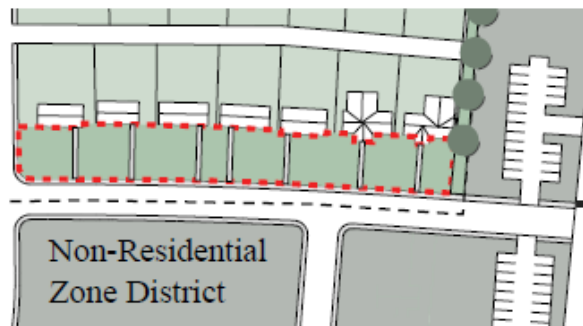

SECTION FIFTEEN: Section 18.15.115 of the Olathe Municipal Code (Unified Development Ordinance) is hereby amended to read as follows:

“18.15.115 Site Design Category 3

~~Composite~~ Site Design Category 3 provides standards to ensure compatible site development in areas designated by *PlanOlathe* as Neighborhood Centers, Urban Centers, Transit Oriented Development Centers and Mixed-Use Residential Neighborhoods. The following ~~general~~ site design standards apply to all projects in Site Design Category 3. [The letters illustrated on Figure 1 below correspond with the site design standards provided within this Section.](#)

Figure 1: Site Design Category 3

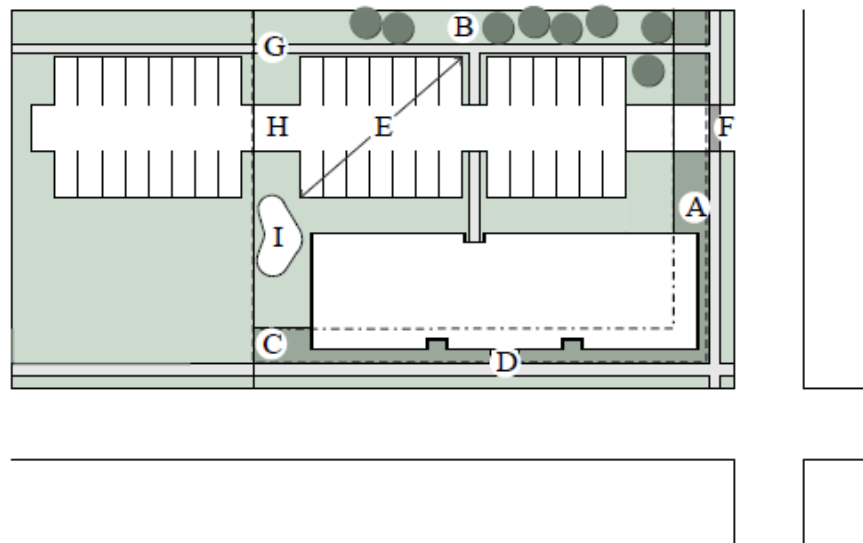

Table 15-12. General Design Standards for Site Design Category 3

Open Space		
A	Landscaping Adjacent to Sidewalks	Required where building façades are not located in the frontage area- See menu options
B	Outdoor Amenity Space	Required for development with more than 65% open space or larger than 4 acres—See menu options

Building Placement

C	Street Frontage Area for Commercial/Mixed-Use Buildings (min./max. 0 feet/15 feet from property line)	
D	Façade Width in Frontage Area (min. % of lot width) — for commercial/mixed-use	30% ¹
E	Parking Pod Size (max. spaces)	40

Connectivity

F	Pedestrian Circulation System	Required — See design standards
G	Additional Pedestrian Connectivity	Required — See menu options
H	Connections to Driveways on Adjacent Properties	Required where possible

Drainage Features

I	Open Drainage and Detention Areas Designed as Amenities	Required — See design options
----------	---	-------------------------------

¹ Exceptions provided for Civic uses. The Planning Official may reduce required façade width in setback area to support preservation of significant trees or tree clusters.

A. Menu of Landscape Options for Site Design Category 3

Development in Site Design Category 3 must provide landscaping along sidewalks where building façades are not located within the minimum frontage area to enhance community image and support pedestrian activity. *Select one of the following options*, [using one of the following methods](#):

1. Planted Buffer with No Fence or Wall

A landscaped area at the sidewalk edge that is at least 20 feet deep with a minimum of 70% porous/permeable surfaces and 50% planted material.

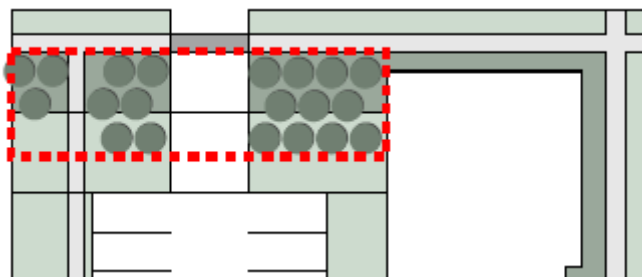

2. Planted Buffer with a Fence or Wall

A landscaped area at the sidewalk edge that is at least 10 feet deep with a minimum of 70% porous/permeable surfaces and 50% planted material. A fence or wall ~~shall~~ must be located within the landscape area and ~~shall~~ include posts, columns, and/or pedestrian gateways a minimum of every 100 feet. (↔ See § [18.50.050](#) for fence height and design).

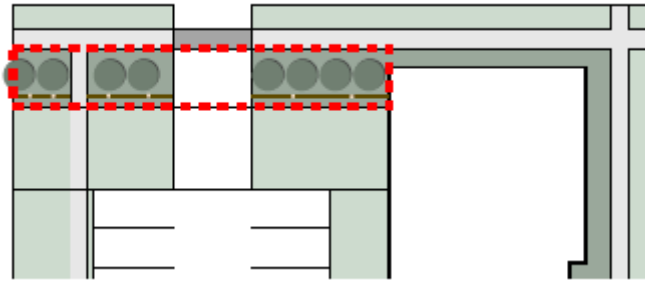

3. Plaza or Courtyard

An area that is paved but also includes amenities - These may include plant materials, sculptural or water features, public art or outdoor seating.

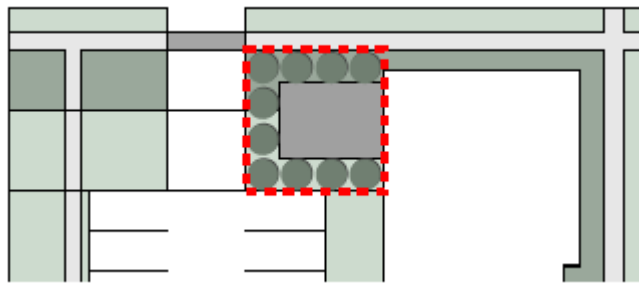

B. ~~Menu of Outdoor Amenity Space Options for Site Design Category 3~~

Development in Site Design Category 3 that is greater than 4 acres in size or includes more than 65% open space (low coverage of buildings) must include outdoor amenity space to enhance the public realm and promote pedestrian activity. Select one or more of the following ~~options~~ methods to cover at least 10% of the site area:

1. Plaza or Courtyard

A common use area directly accessible from adjoining buildings that includes decorative paving, street furniture, planters and/or pergolas or other shade structures.

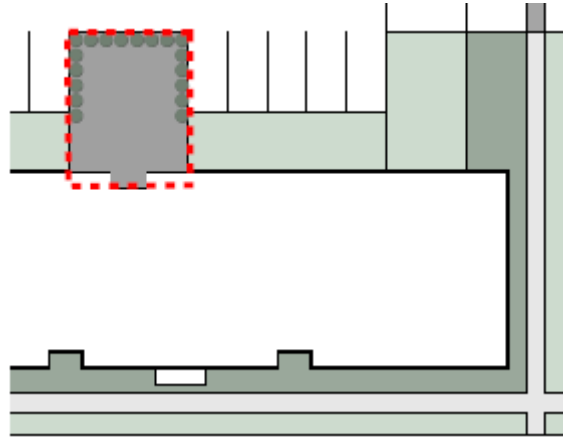

2. Common Green Area

A [common green space](#) shared by users of the development that may include a lawn, a stand of trees, or shrubs.

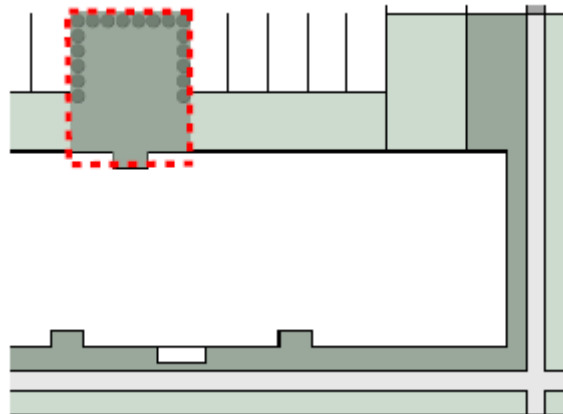

3. Water Feature

A fountain or decorative pool shared by users of the development (note that properly designed artificial drainage areas may also be used to meet common open space standards).

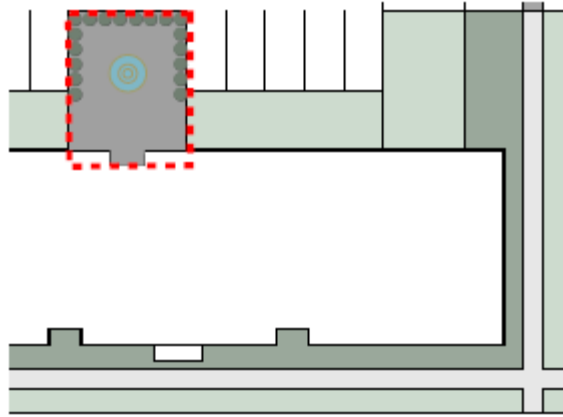

4. Natural Feature

Stands of mature trees or natural drainage areas retained as an amenity for users of the development.

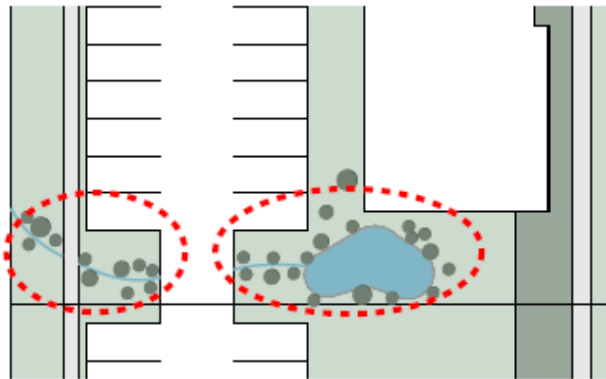

C. Street Frontage Area ~~for Site Design Category 3~~

[See Table 15-12.](#) Street frontage area for commercial and mixed-use buildings in Site Design Category 3 must be a maximum of 15 feet as measured from the property line.

D. Façade Width in Frontage Area ~~for Site Design Category 3~~

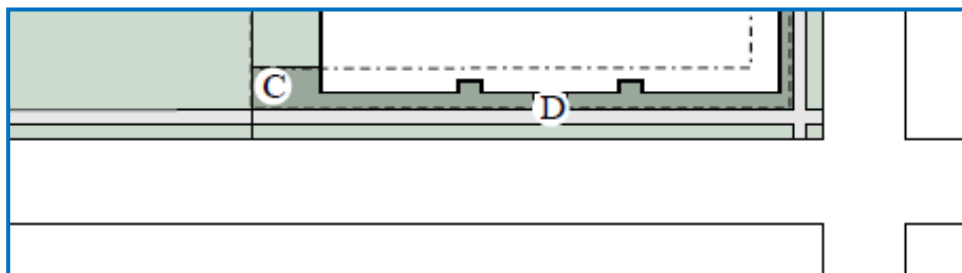

~~See Table 15-12.~~ [The façade width within the frontage area of a site must be a minimum of 30% of the lot width for commercial and mixed-use buildings as illustrated in Figure 1 of this Section. The Planning Official may reduce the required façade width in the setback area to support preservation of significant trees or tree clusters.](#)

E. ~~Maximum Parking Pod Size for Site Design Category 3~~

~~See Table 15-12.~~ [The maximum number of parking stalls allowed in one parking pod, as illustrated in Figure 1 of this Section, is 40.](#)

F. ~~Design Standards for Pedestrian Street Connectivity in Site Design Category 3~~

Development in Site Design Category 3 must provide an internal public or private street system with a connectivity ratio of at least 1.7 (see § [18.30.220](#)).

G. ~~Menu of Additional Pedestrian Connection Connectivity Options for Site Design Category 3~~

1. ~~Design Standards for Pedestrian Circulation System in Site Design Category 3~~

Development in Site Design Category 3 must provide a coordinated pedestrian and bicycle system to provide convenient pedestrian access within the site and to adjacent development. All sites must provide:

- [a.](#) Direct pedestrian connections between buildings on the site; and
- [b.](#) Paving materials that differentiate pedestrian ways from parking spaces and automobile travel lanes; and
- [c.](#) Direct pedestrian connections to adjacent transit stops.

[2. Additional Pedestrian Connection Options](#)

Development in Site Design Category 3 must provide enhanced pedestrian connections to encourage pedestrian use, integrate with surrounding land uses or connect to regional paths and trails. Select at least two of the following ~~options~~ [methods](#):

a. 1. Pedestrian Gateway

Provide at least one defined pedestrian gateway into the site using landscape and hardscape materials.

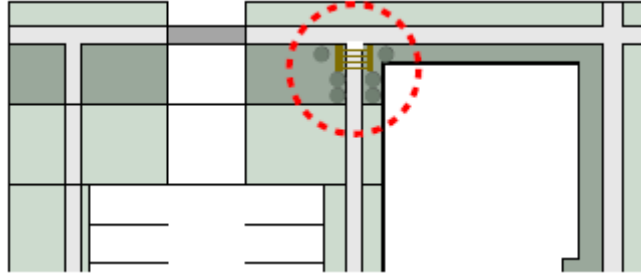

b. 2. Cross Property Connection

Provide at least one dedicated pedestrian connection across the development defined with wide sidewalks, special paving material or landscaping.

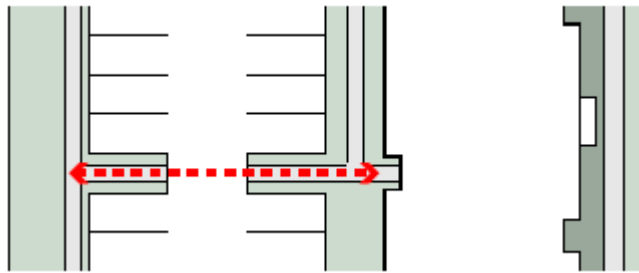

c. 3. Pedestrian Connection to Adjacent Development

Provide at least one dedicated off-street pedestrian and bicycle connection to an adjacent residential, commercial or mixed-use development, or to an adjacent transit stop.

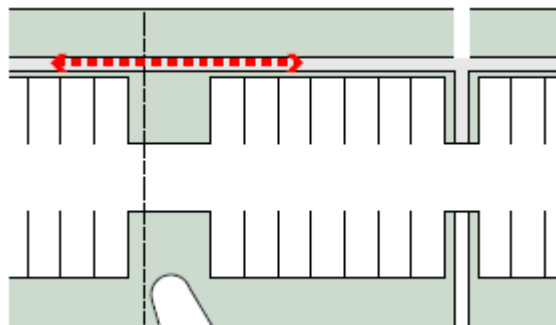

d. 4. Pedestrian Connection to Regional Trail

Provide at least one dedicated pedestrian and bicycle connection to an adjacent pedestrian or multi-use trail.

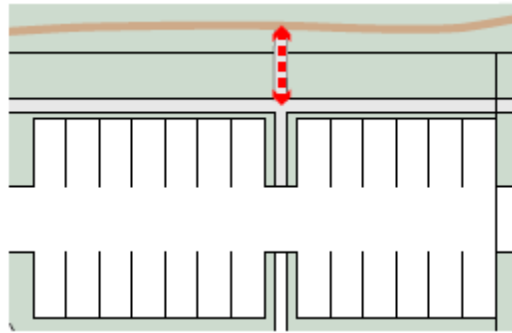

H. Connectivity to Adjacent Driveways ~~for Site Design Category 3~~

~~See Table 15-12. Development in Site Design Category 3 requires connections to driveways on adjacent properties where possible.~~

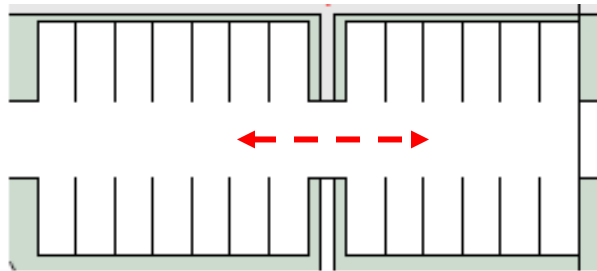

I. Drainage Features ~~for Site Design Category 3~~

Open drainage and detention areas visible to the public ~~shall~~ must be incorporated into the design of the site as an attractive amenity or focal point, using at least one of the following ~~tools~~ methods:

1. Pond or ~~f~~ountain

A wet-bottom basin in a prominent location that is enhanced with decorative features such as fountains, waterfalls, and/or extensive landscaping.

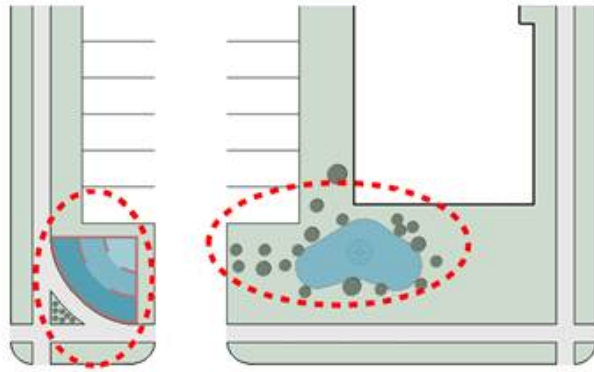

2. Landscaped **b**Basin or **e**Channel

A dry-bottom basin or channel that is maintained as extensively landscaped open space or yard area, designed with shallow slopes and a curvilinear, non-geometric shape to avoid an artificial appearance.

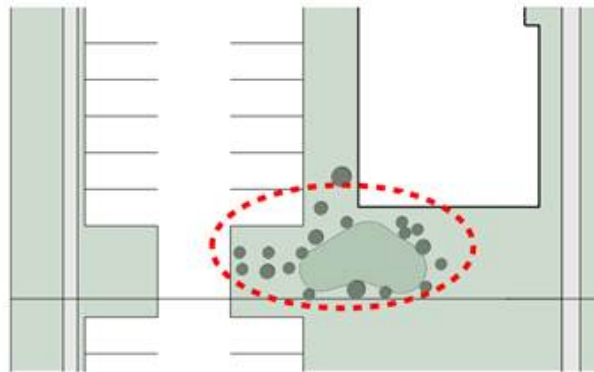

3. Natural **d**Drainage **f**Feature

Preservation of natural drainage areas including existing trees and vegetation. If existing trees and vegetation are missing or removed, new trees, shrubs, and plants should be added to restore the appearance of natural landscaping.

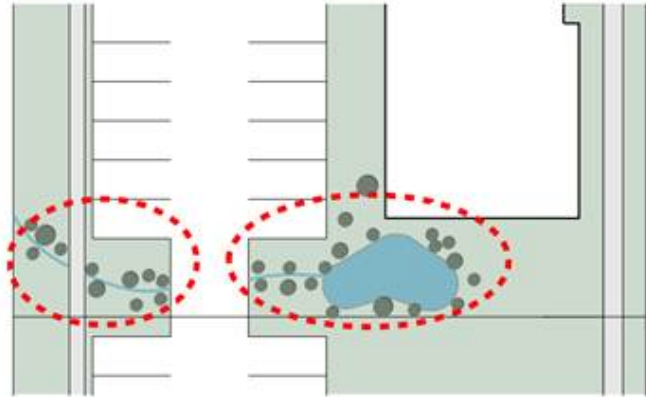

4. Geometric Basin

Artificial geometrically shaped basins should generally be avoided, but may be used in areas that are not visible to the public or from adjacent property.

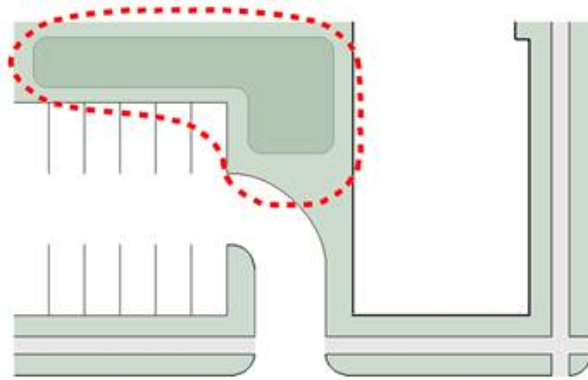

(Ord. 15-16 §3, 2015)"

SECTION SIXTEEN: Section 18.15.120 of the Olathe Municipal Code (Unified Development Ordinance) is hereby amended to read as follows:

“18.15.120 Site Design Category 4

~~Composite~~ Site Design Category 4 provides standards to ensure compatible site development in areas designated by *PlanOlathe* as Commercial Corridors, Community Commercial Centers and Regional Commercial Centers. The following ~~general~~ site design standards apply to all projects in Site Design Category 4. The letters illustrated on Figure 1 below correspond with the site design standards provided within this Section.

Figure 1: Site Design Category 4

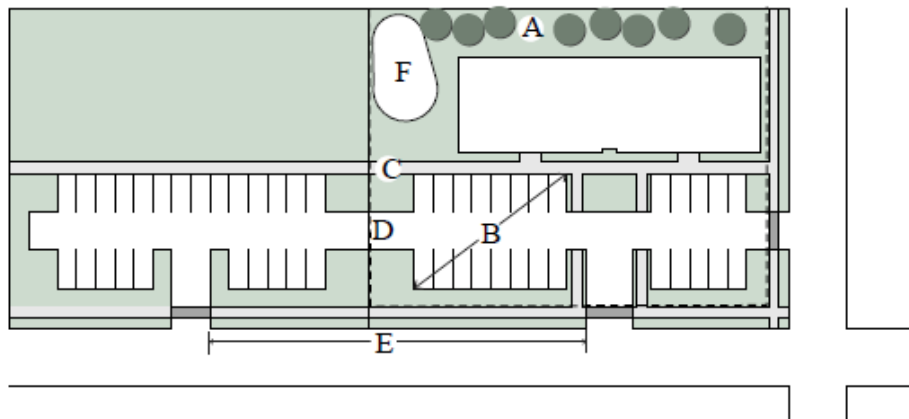

Table 15-13. General Design Standards for Site Design Category 4

Open Space		
A	Outdoor Amenity Space	Required for development with more than 65% open space or larger than 4 acres—See menu options
Parking Placement		
B	Parking Pod Size (max. spaces)	80
Connectivity		
C	Pedestrian Connections	Required—See menu options
D	Connections to Driveways on Adjacent Properties	Required where possible
E	Distance between curb cuts (min.)	Refer to City's Access Management Plan
Drainage Features		

F Open Drainage and Detention Areas Designed as Amenities Required—See design options

Buffer Area Adjacent to Other Uses

G Buffer Area Adjacent to Residential Uses Required—See design options

A. Menu of Outdoor Amenity Space Options for Site Design Category 4

Development in Site Design Category 4 that is greater than 4 acres in size or includes more than 65% open space must include outdoor amenity space to enhance the public realm and promote pedestrian activity. Select one or more of the following [options](#) [methods](#) to cover at least 10% of the site area:

1. Plaza or Courtyard

A common use area directly accessible from adjoining buildings that includes decorative paving, street furniture, planters and/or pergolas.

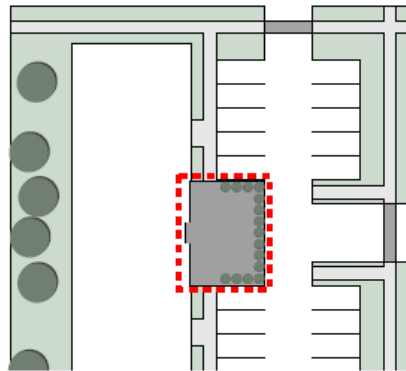

2. Common Green Area

A [common](#) green [space](#) shared by users of the development that may include a lawn, a stand of trees, or shrubs.

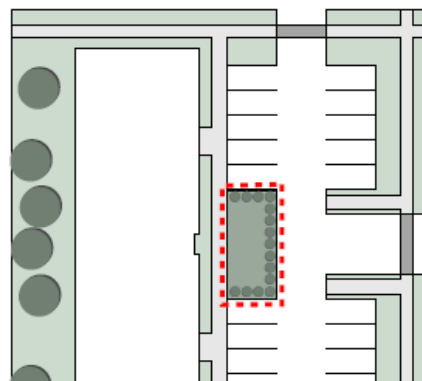

3. Water Feature

A fountain or decorative pool shared by users of the development (note that properly designed artificial drainage areas may also be used to meet common open space standards).

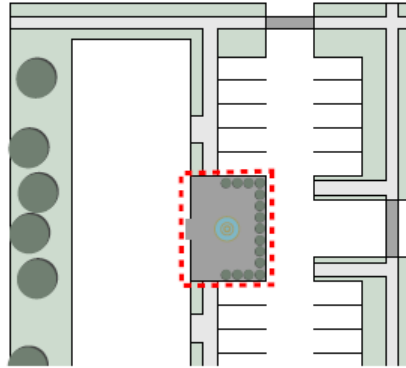

4. Natural Feature

Stands of mature trees or natural drainage areas retained as an amenity for users of the development.

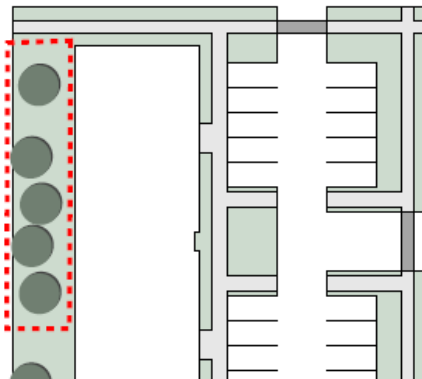

B. ~~Maximum~~ Parking Pod Size ~~for Site Design Category 4~~

~~See Table 15-13.~~ [The maximum number of parking stalls allowed in one parking pod, as illustrated in Figure 1 of this Section, is 80.](#)

C. ~~Menu of~~ Pedestrian Connection Options ~~for Site Design Category 4~~

Development in Site Design Category 4 must provide pedestrian connections from surrounding development, parking and adjacent transit stops. ~~Select~~ [, using](#) at least one of the following ~~tools~~ [methods](#):

1. Pedestrian Gateway

Provide at least one defined pedestrian gateway into the site using landscape and hardscape

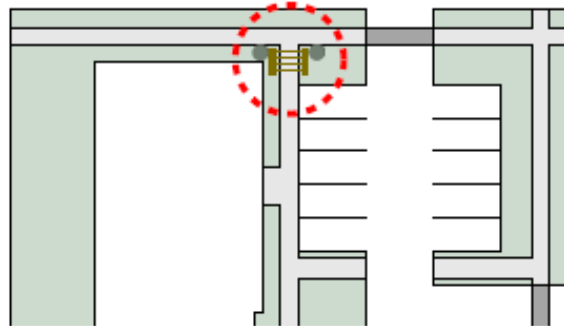

materials.

2. Cross Property Connection

Provide at least one dedicated pedestrian connection across the development defined with wide sidewalks, special paving material or landscaping.

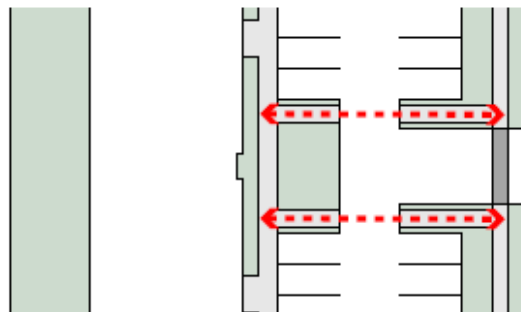

3. Pedestrian Connection to Adjacent Development

Provide at least one dedicated off-street pedestrian and bicycle connection to an adjacent residential, commercial or mixed-use development, or to an adjacent transit stop.

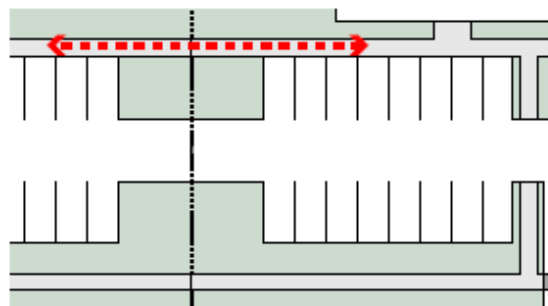

4. Pedestrian Connection to Regional Trail

Provide at least one dedicated pedestrian and bicycle connection to an adjacent pedestrian or multi-use trail.

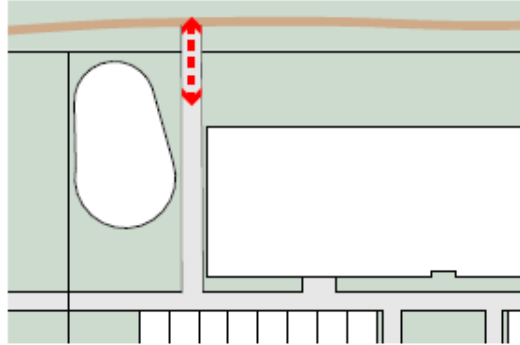

D. Connectivity to Adjacent Driveways ~~for Site Design Category 4~~

~~See Table 15-13. Connections to driveways on adjacent properties are required where possible.~~

E. Distance between Curb Cuts ~~for Site Design Category 4~~

~~See Table 15-13. For the minimum distance between curb cuts, refer to the City's Access Management Plan.~~

F. Drainage Features ~~for Site Design Category 4~~

Open drainage and detention areas visible to the public ~~shall~~ must be incorporated into the design of the site as an attractive amenity or focal point, using at least one of the following ~~tools~~ methods:

1. Pond or ~~f~~ountain

A wet-bottom basin in a prominent location that is enhanced with decorative features such as fountains, waterfalls, and/or extensive landscaping.

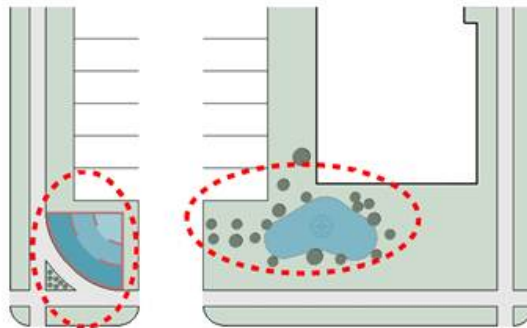

2. Landscaped **b**Basin or **c**Channel

A dry-bottom basin or channel that is maintained as extensively landscaped open space or yard area, designed with shallow slopes and a curvilinear, non-geometric shape to avoid an artificial appearance.

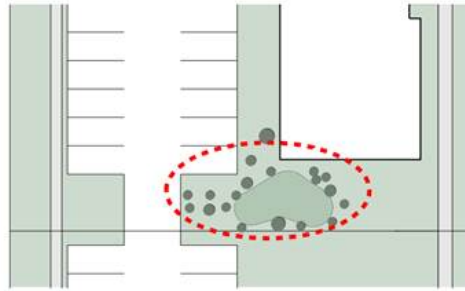

3. Natural **d**Drainage **f**Feature

Preservation of natural drainage areas including existing trees and vegetation. If existing trees and vegetation are missing or removed, new trees, shrubs, and plants should be added to restore the appearance of natural landscaping.

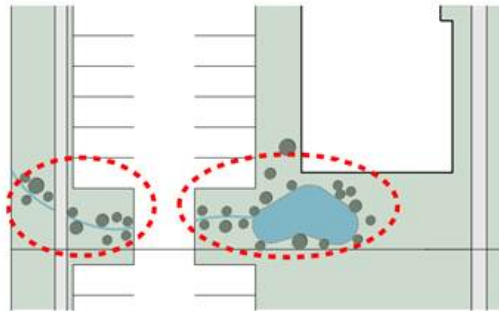

4. Geometric **b**Basin

Artificial geometrically shaped basins should generally be avoided, but may be used in areas that are not visible to the public or from adjacent property.

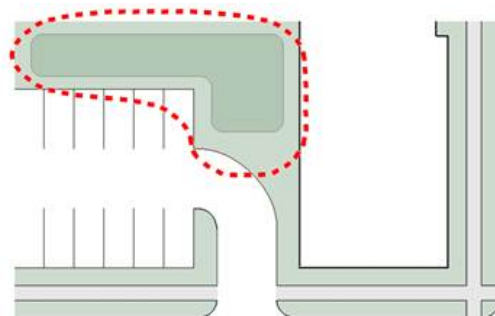

G. Required Landscaped Buffer Area for Site Design Category 4

Buffer standards apply to development in Site Design Category 4 ~~that is~~ when located adjacent to a residential zoning district. Standards are intended to mitigate visual and noise impacts on surrounding land uses.

1. Increased Setback

Buildings must be set back at least 40 feet from an adjoining R-1 or R-2 zoning district or designated open space.

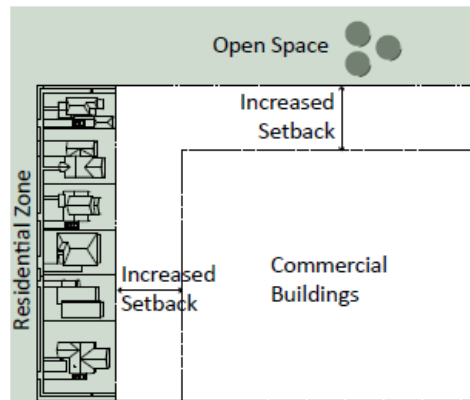

2. Perimeter Landscaping

One of the following landscaping strategies must be used within the required minimum setback area on the edges of an ~~an industrial~~ commercial site that directly abuts an R-1 or R-2 zoning district or designated open space:

a. Planted Buffer with No Fence or Wall

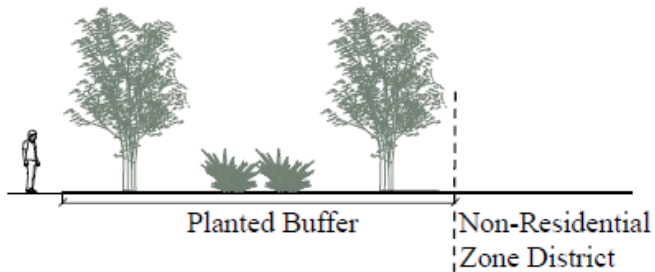

A landscaped area at the sidewalk edge that is at least 40 feet deep with a minimum of 70% porous/permeable surfaces and 50% planted material.

b. Planted Buffer with a Fence or Wall

A landscaped area of at least 15 feet between the sidewalk edge and a fence or wall with a minimum of 70% porous/permeable surfaces and 50% planted material. A fence or wall shall must be located within the landscape area and shall must include posts, columns, and/or pedestrian gateways a minimum of every 100 feet. (Ord. 15-16 §3, 2015)

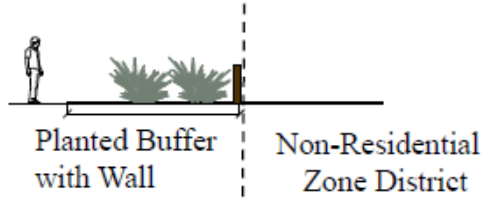

(↔ See § [18.50.050](#) for fence height and design)"

SECTION SEVENTEEN: Section 18.15.125 of the Olathe Municipal Code (Unified Development Ordinance) is hereby amended to read as follows:

"18.15.125 Site Design Category 5

~~Composite~~ Site Design Category 5 provides standards to ensure compatible site development in areas designated by *PlanOlathe* as Employment Areas. The following ~~general~~ site design standards apply to all projects in Site Design Category 5: [The letters illustrated on Figure 1 below correspond with the site design standards provided within this Section.](#)

[Figure 1: Site Design Category 5](#)

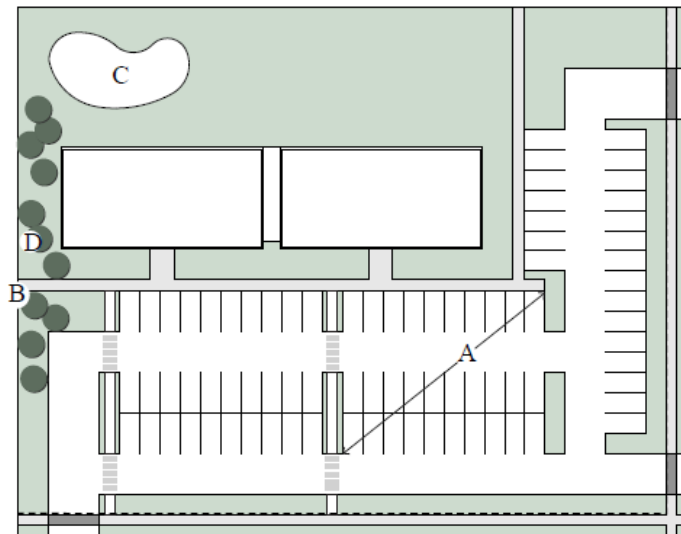

Table 15-14. General Design Standards for Site Design Category 5

Parking Placement		
A	Parking Pod Size (max. spaces)	160
Connectivity		
B	Pedestrian Connections	Required—See menu options
Drainage Features		
C	Open Drainage and Detention Areas Designed as Amenities	Required—See design options
Buffer Area Adjacent to Other Uses		
D	Buffer Area Adjacent to Non-Commercial and Industrial Uses	Required—See design options

A. Maximum Parking Pod Size for Site Design Category 5

See Table 15-14. The maximum number of parking stalls allowed in one parking pod, as illustrated in Figure 1 of this Section, is 160.

B. Menu of Pedestrian Connection Options for Site Design Category 5

Development in Site Design Category 5 must provide pedestrian connections from surrounding development, parking and adjacent transit stops. Select, using at least one of the following tools methods:

1. Pedestrian Gateway

Provide at least one defined pedestrian gateway into the site using landscape and hardscape materials.

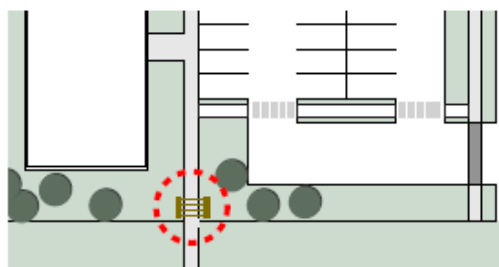

2. Cross Property Connection

Provide at least one dedicated pedestrian connection across the development defined with wide sidewalks, special paving material or landscaping.

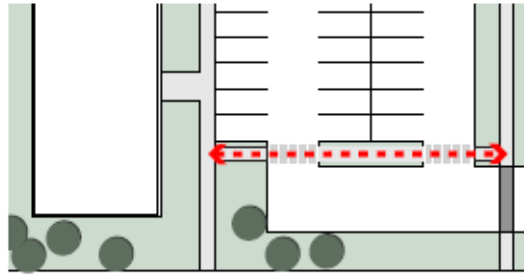

3. Pedestrian Connection to Adjacent Development

Provide at least one dedicated off-street pedestrian and bicycle connection to an adjacent residential, commercial or mixed-use development, or to an adjacent transit stop.

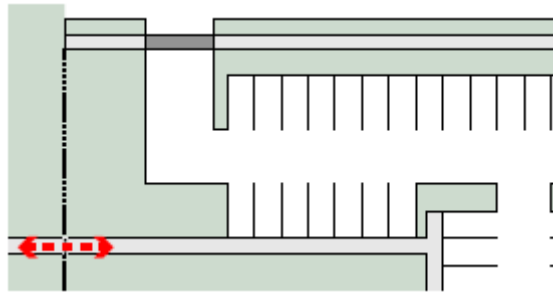

4. Pedestrian Connection to Regional Trail

Provide at least one dedicated pedestrian and bicycle connection to an adjacent pedestrian or multi-use trail.

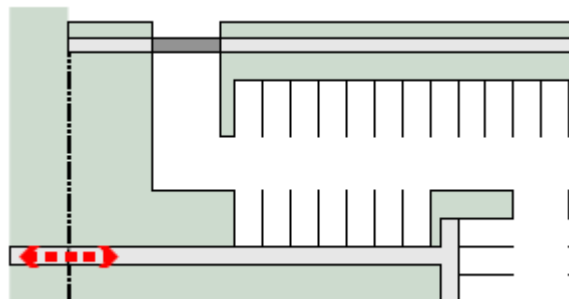

C. Drainage Features ~~for Site Design Category 5~~

Open drainage and detention areas visible to the public ~~shall~~ must be incorporated into the design of the site as an attractive amenity or focal point, using at least one of the following ~~tools~~ methods:

1. Pond or Fountain

A wet-bottom basin in a prominent location that is enhanced with decorative features such as fountains, waterfalls, and/or extensive landscaping.

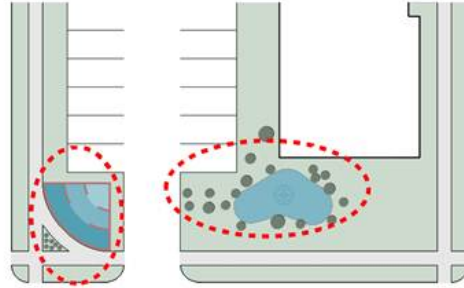

2. Landscaped Basin or Channel

A dry-bottom basin or channel that is maintained as extensively landscaped open space or yard area, designed with shallow slopes and a curvilinear, non-geometric shape to avoid an artificial appearance.

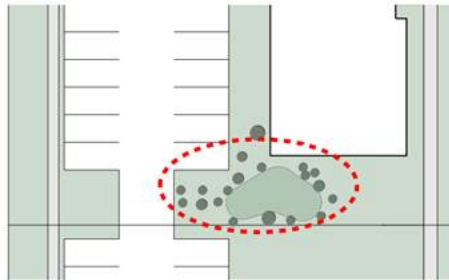

3. Natural Drainage Feature

Preservation of natural drainage areas including existing trees and vegetation. If existing trees and vegetation are missing or removed, new trees, shrubs, and plants should be added to restore the appearance of natural landscaping.

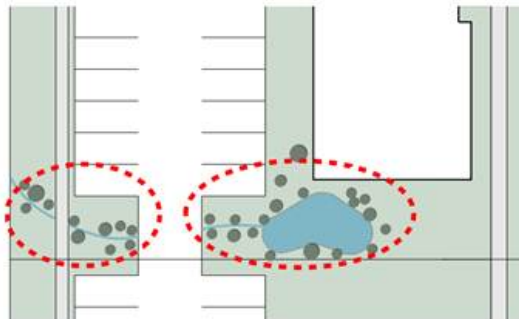

4. Geometric Basin

Artificial geometrically shaped basins should generally be ~~avoided, but~~ avoided but may be used in areas that are not visible to the public or from adjacent property.

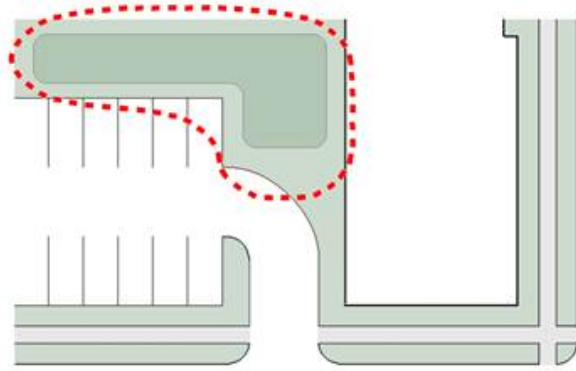

D. ~~Required Landscaped Buffer Area for Site Design Category 5~~

Buffer standards apply to development in Site Design Category 5 ~~that is~~ when located adjacent to any arterial street or an agricultural, residential, or business park zoning district. ~~any non-commercial or industrial zoning district.~~ Standards are intended to mitigate visual and noise impacts on surrounding land uses.

1. Increased Setback

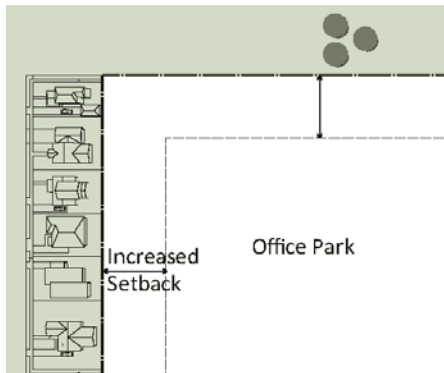

Buildings must be set back at least 40 feet from an adjoining arterial street or non-residential zoning district and 100 feet from an adjoining R-1 or R-2 zoning district or designated open space.

2. Perimeter Landscaping

One of the following landscaping strategies must be used within the required minimum setback area on the edges of an industrial site in the employment area that directly abuts an arterial street or any non-commercial or non-industrial zoning district:

a. Planted Buffer with No Fence or Wall

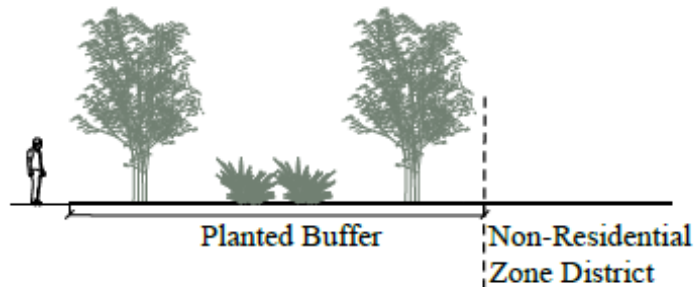

A landscaped area at the sidewalk edge that is at least 40 feet deep with a minimum of 70% porous/permeable surfaces and 50% planted material.

b. Planted Buffer with a Fence or Wall

A landscaped area of at least 15 feet between the sidewalk edge and a fence or wall with a minimum of 70% porous / permeable surfaces and 50% planted material. A fence or wall shall must be located within the landscape area and shall include posts, columns, and/or pedestrian gateways a minimum of every 100 feet. (Ord. 15-16 §3, 2015)"

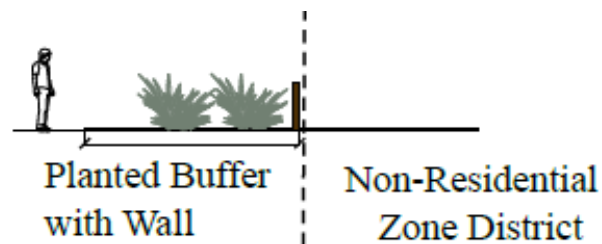

(⇒ See § [18.50.050](#) for fence height and design)

SECTION EIGHTEEN: Section 18.15.130 of the Olathe Municipal Code (Unified Development Ordinance) is hereby amended to read as follows:

“18.15.130 Site Design Category 6

~~Composite~~ Site Design Category 6 provides standards to ensure compatible site development in areas designated by *PlanOlathe* as Industrial Areas. The following ~~general~~ site design standards apply to all projects in Site Design Category 6: [The letters illustrated on Figure 1 below correspond with the site design standards provided within this Section.](#)

Figure 1: Site Design Category 6

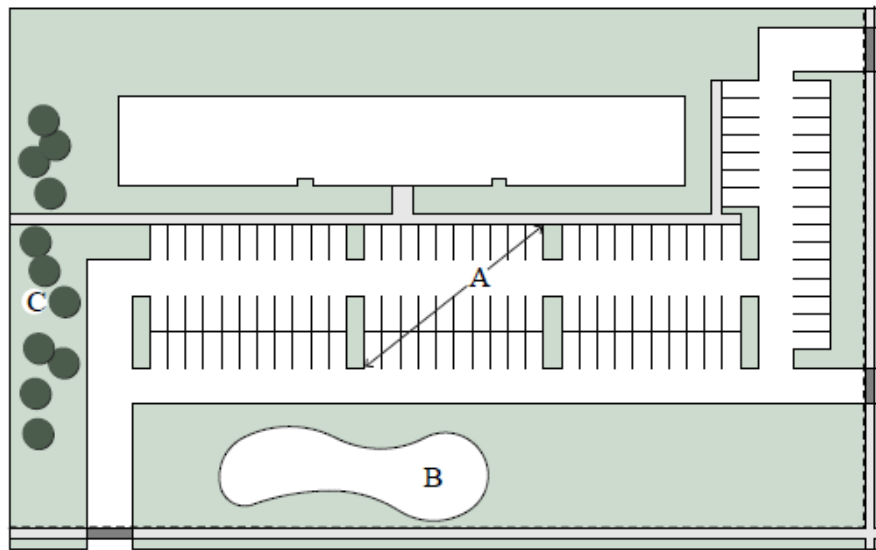

Table 15-15. General Design Standards for Site Design Category 6

Parking Placement		
A	Parking Pod Size (max. spaces)	320
Drainage Features		
B	Open storm drainage and detention areas visible to the public designed to reduce visual impacts and provide a pedestrian amenity	Required – See design options
Buffer Area Adjacent to Other Uses		
C	Landscaped buffer area adjacent to arterial streets or non-industrial uses	Required – See design options

A. Maximum Parking Pod Size for Site Design Category 6

See [Table 15-15](#). The maximum number of parking stalls allowed in one parking pod, as illustrated in [Figure 1](#) of this Section, is 320.

B. Drainage Features ~~for Site Design Category 6~~

Open drainage and detention areas visible to the public ~~shall~~ [must](#) be incorporated into the design of the site as an attractive amenity or focal point, using at least one of the following ~~tools~~ [methods](#):

1. Pond or fountain

A wet-bottom basin in a prominent location that is enhanced with decorative features such as fountains, waterfalls, and/or extensive landscaping.

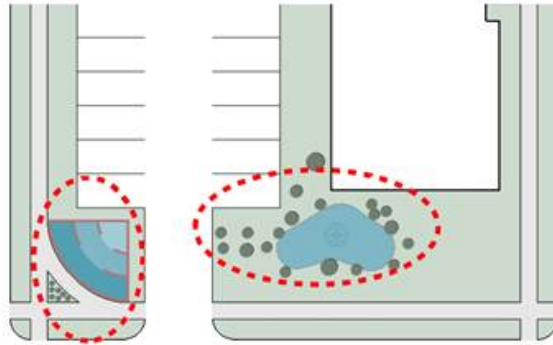

2. Landscaped ~~b~~Basin or ~~e~~Channel

A dry-bottom basin or channel that is maintained as extensively landscaped open space or yard area, designed with shallow slopes and a curvilinear, non-geometric shape to avoid an artificial appearance.

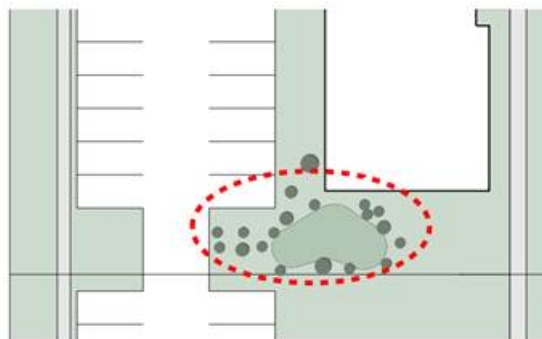

3. Natural ~~d~~Drainage ~~f~~Feature

Preservation of natural drainage areas including existing trees and vegetation. If existing trees and vegetation are missing or removed, new trees, shrubs, and plants should be added to restore the appearance of natural landscaping.

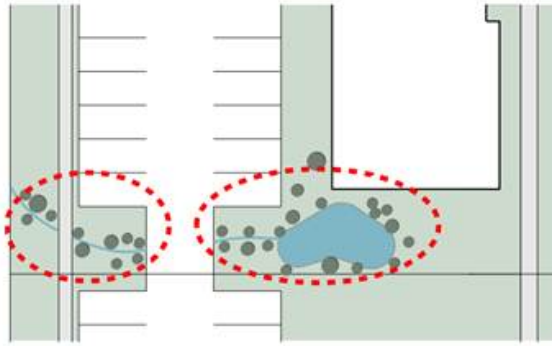

4. Geometric ~~b~~Basin

Artificial geometrically shaped basins should generally be ~~avoided, but~~ [avoided but](#) may be used in areas that are not visible to the public or from adjacent property.

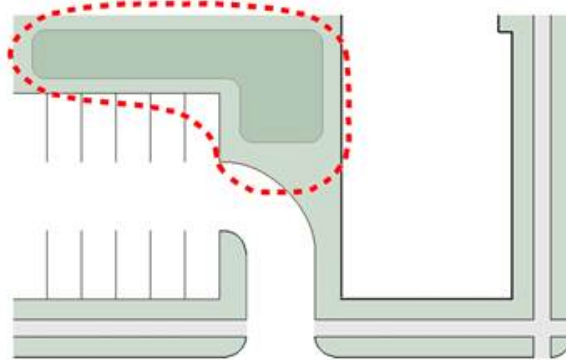

C. Required Landscaped Buffer Area for Site Design Category 6

Buffer standards apply to development in Site Design Category 6 ~~that is~~ when located adjacent to any arterial street or any non-industrial zoning district. Standards are intended to mitigate visual and noise impacts on surrounding land uses.

1. Increased Setback

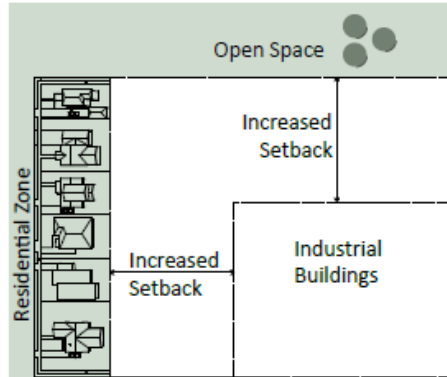

Buildings must be set back at least 50 feet from an adjoining arterial street or non-residential zoning district and 200 feet from an adjoining R-1 or R-2 zoning district or designated open space.

2. Perimeter Landscaping

One of the following landscaping strategies must be used within the required minimum setback area on the edges of an industrial site that directly abuts an arterial street or any non-industrial zoning district:

a. Planted Buffer with No Fence or Wall

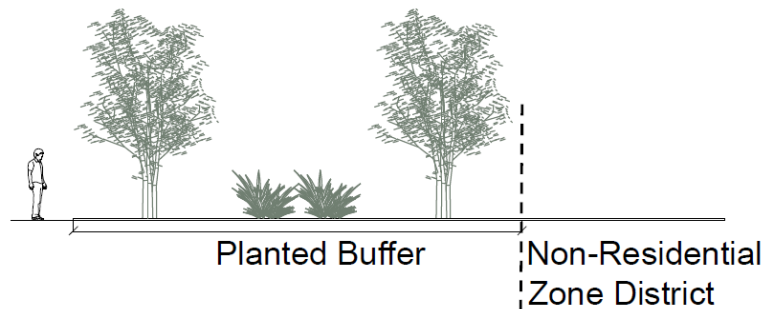

A landscaped area at the sidewalk edge that is at least 50 feet deep with a minimum of 70% porous/permeable surfaces and 50% planted material.

b. Planted Buffer with a Fence or Wall

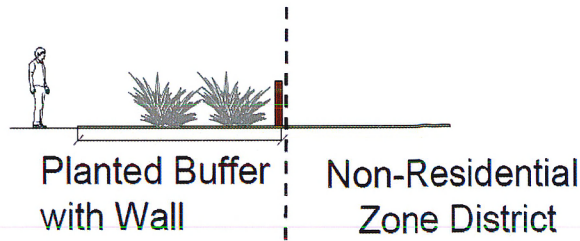

A landscaped area of at least 20 feet between the sidewalk edge and a fence or wall with a minimum of 70% porous / permeable surfaces and 50% planted material. A fence or wall **shall must** be located within the landscape area and **should** include posts, columns, and/or pedestrian gateways a minimum of every 100 feet. (Ord. 15-16 §3, 2015)"

SECTION NINETEEN: Existing Sections 18.01.020, and Chapter 18.15, are hereby specifically repealed.

SECTION TWENTY: This Ordinance shall take effect from and after its publication as provided by law.

PASSED by the Governing Body this 15th day of October 2019.

SIGNED by the Mayor this 15th day of October 2019.

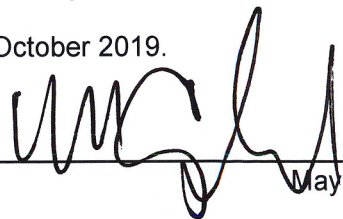

Mayor

ATTEST:

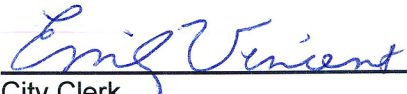

City Clerk
(Seal)

APPROVED AS TO FORM:



City Attorney

